

JVC

SERVICE MANUAL

MODEL
**JR-S81M/S81W/
S81H**

STEREO RECEIVER



Contents

	Page
1. Specifications	2
2. Removal of Procedures	
2-(1) Top Cover and Bottom Plate	3
2-(2) Front Panel	4
3. Main Part Locations and Part Numbers	4
4. Exploded Views and Part Numbers	
4-(1) Front Panel	5
4-(2) Rear Panel	6
5. Dial Stringing Procedure	7
6. FM/AM Tuner Alignment Procedures	
6-(1) FM Section	9
6-(2) AM Section	11
7. Printed Circuit Board Ass'y and Parts List	
7-(1) TFC-20C FM/AM Tuner & Equalizer Amp. P.C. Board Ass'y	12
7-(2) TPS-93G AC Fuse P.C. Board Ass'y	19
7-(3) TSC-107 Speaker Switch P.C. Board Ass'y	20
7-(4) TPS-124A Lamp P.C. Board Ass'y	20
7-(5) TAP-256C Audio Amp. P.C. Board Ass'y	21
7-(6) TAC-491 Volume and Tone Control P.C. Board Ass'y	25
8. Packing Materials and Part Numbers	26
9. Accessories List	27
10. Transistor, I.C. and Diode Lead Identification	27
11. JR-S81 Schematic Diagram	28
12. Parts List with Specified Numbers for Designated Areas	30

Note:

When replacing the parts marked with , be sure to use the designated parts to ensure safety.

1. Specifications

	JR-S81M	JR-S81W	JR-S81H
Dimensions (cm)	H : 15.1 (6")	15.1 (6")	15.1 (6")
	W : 47.4 (18-11/16")	49.8 (19-5/8")	53.4 (21-1/16")
	D : 35.0 (13-13/16")	35.0 (13-13/16")	37.0 (14-5/8")
Weight (Net)	: 9.4 kg (20.8 lbs.)	10.4 kg (23.0 lbs.)	9.6 kg (21.2 lbs.)
Amplifier Section			
RMS Power Both channels driven	: 35 watts per channel, min. RMS at 8 ohms, from 20 Hz to 20 kHz with no more than 0.5 % total harmonic distortion.		
RMS Power Both channels driven at 1 kHz	: 38 W per channel at 8 Ω 43 W per channel at 4 Ω		
Total Harmonic Distortion	: 0.5 % at rated output power		
Damping Factor	: 40 at 8 Ω		
Input Sensitivity, Impedance	: Phono: 2.5 mV/50 k Ω AUX: 200 mV/50 k Ω Tape Mon: 200 mV/50 k Ω		
Recording Output Level	: 150 mV (Pin) 30 mV/80 k Ω (DIN)		
Frequency Response	: 20 Hz – 20 kHz $^{+0}_{-0.8}$ dB		
Bass Control	: ± 10 dB at 50 Hz		
Treble Control	: ± 10 dB at 10 kHz		
FM Tuner Section			
Usable Sensitivity	(IHF): Mono 12.1 dBf (DIN): Mono 1.2 μ V/75 Ω S/N 26 dB, 1.8 μ V/300 Ω		
Total Harmonic Distortion at 1 kHz and 100 % Modulation	: 0.2 % (Mono) at 100 Hz or 1 kHz 0.6 % (Mono) at 6 kHz 0.4 % (Stereo) at 100 Hz or 1 kHz 0.8 % (Stereo) at 6 kHz		
Signal to Noise Ratio	: 78 dB (Mono), 70 dB (Stereo)		
Selectivity	: 70 dB IHF Alternated		
Capture Ratio	: 1.5 dB		
Image Rejection	: 60 dB		
IF Rejection	: 80 dB		
Stereo Separation	: 40 dB at 1 kHz, 30 dB at 50 Hz to 10 kHz		
AM Tuner Section			
Usable Sensitivity	: MW 30 μ V, 300 μ V/m at 1000 kHz		
Image Rejection	: MW 45 dB		
Selectivity	: MW 30 dB		
IF Rejection	: MW 50 dB		
Signal to Noise Ratio	: MW 55 dB		

Power Supply Section

Designated Areas	Line Voltage & Frequency	Power Consumption
U.S.A.	AC 120 V, 60 Hz	175 W (By UL Standard)
CANADA	AC 120 V, 60 Hz	175 W (By CSA Standard)
UK & AUSTRALIA	AC 240 V \sim , 50 Hz	290 W (By BS and SAA Standard)
EUROPEAN CONTINENT	AC 220 V \sim , 50 Hz	280 W (By IEC Standard)
OTHER AREAS	AC 100/120/220/240 V \sim Selectable, 50/60 Hz	280 W (By IEC Standard)

Design and specifications subject to change without notice.

2. Removal of Procedures

2-(1) Top Cover and Bottom Plate

Procedure and Part Numbers

1. Remove 6 screws (Item No. 4) through the both sides of the cover and 2 screws (Item No. 2) from the back of the top cover.
2. Remove the top cover.
3. Remove 4 screws (Item No. 6) from bottom plate (Item No. 5) and remove the bottom plate from the chassis.

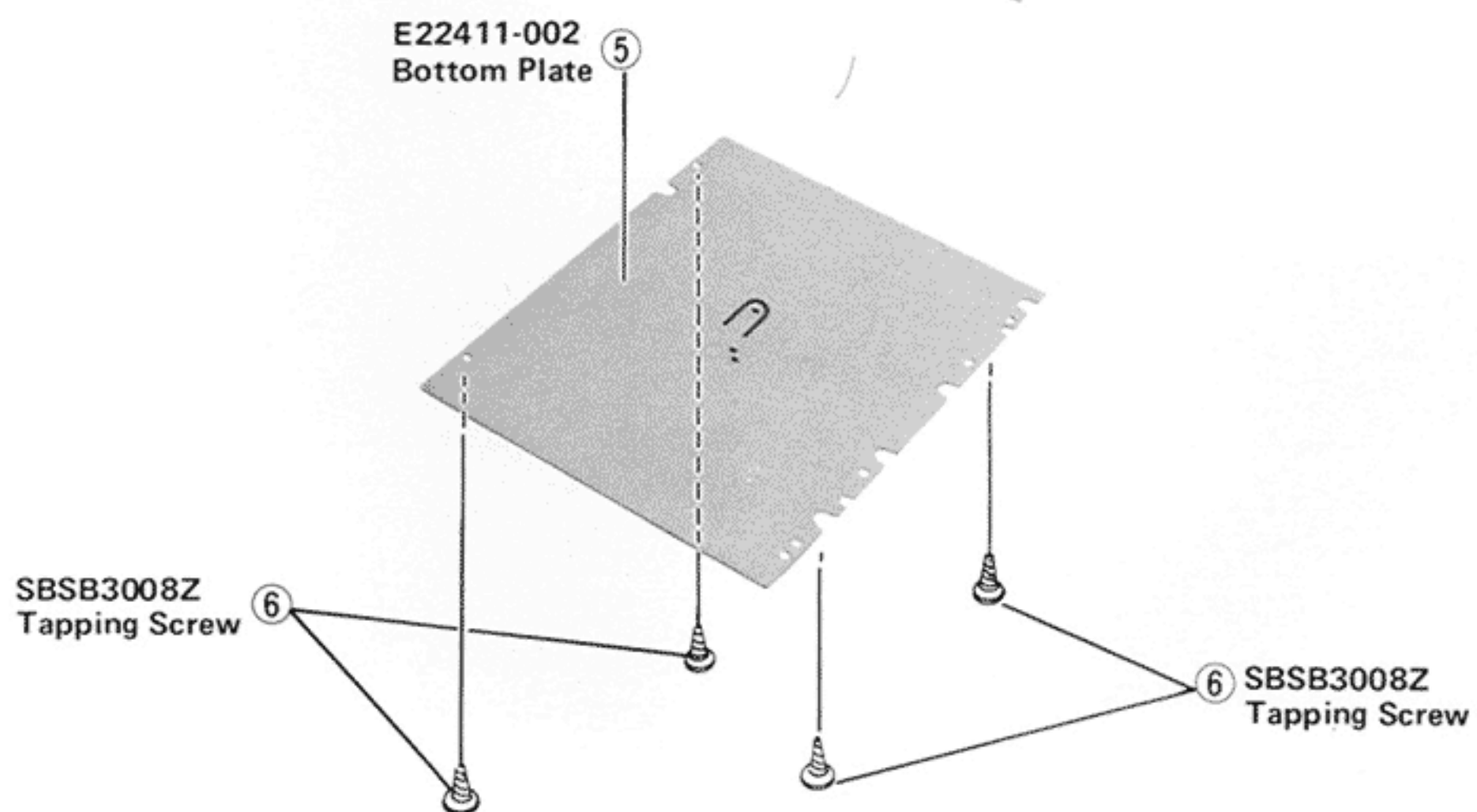
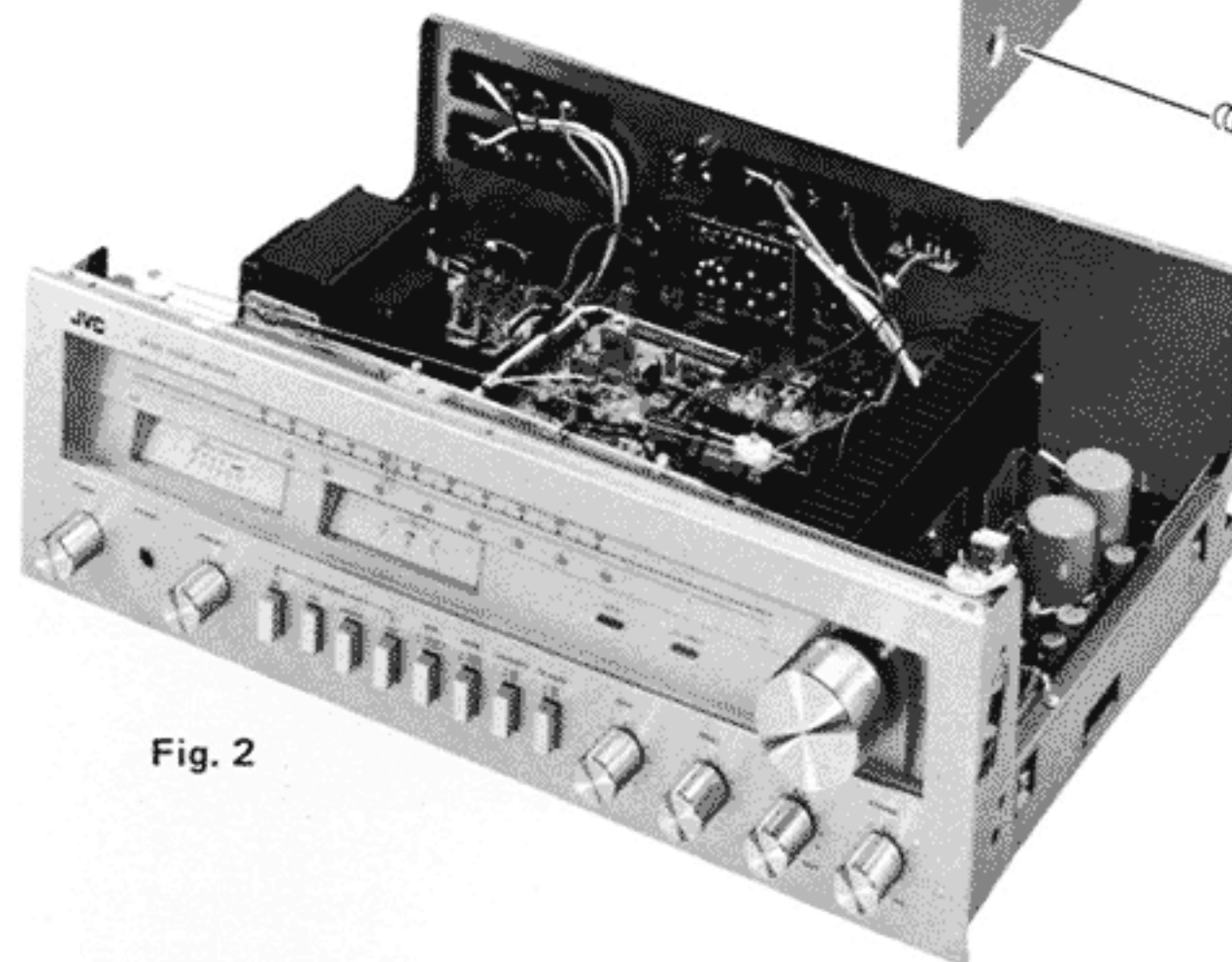
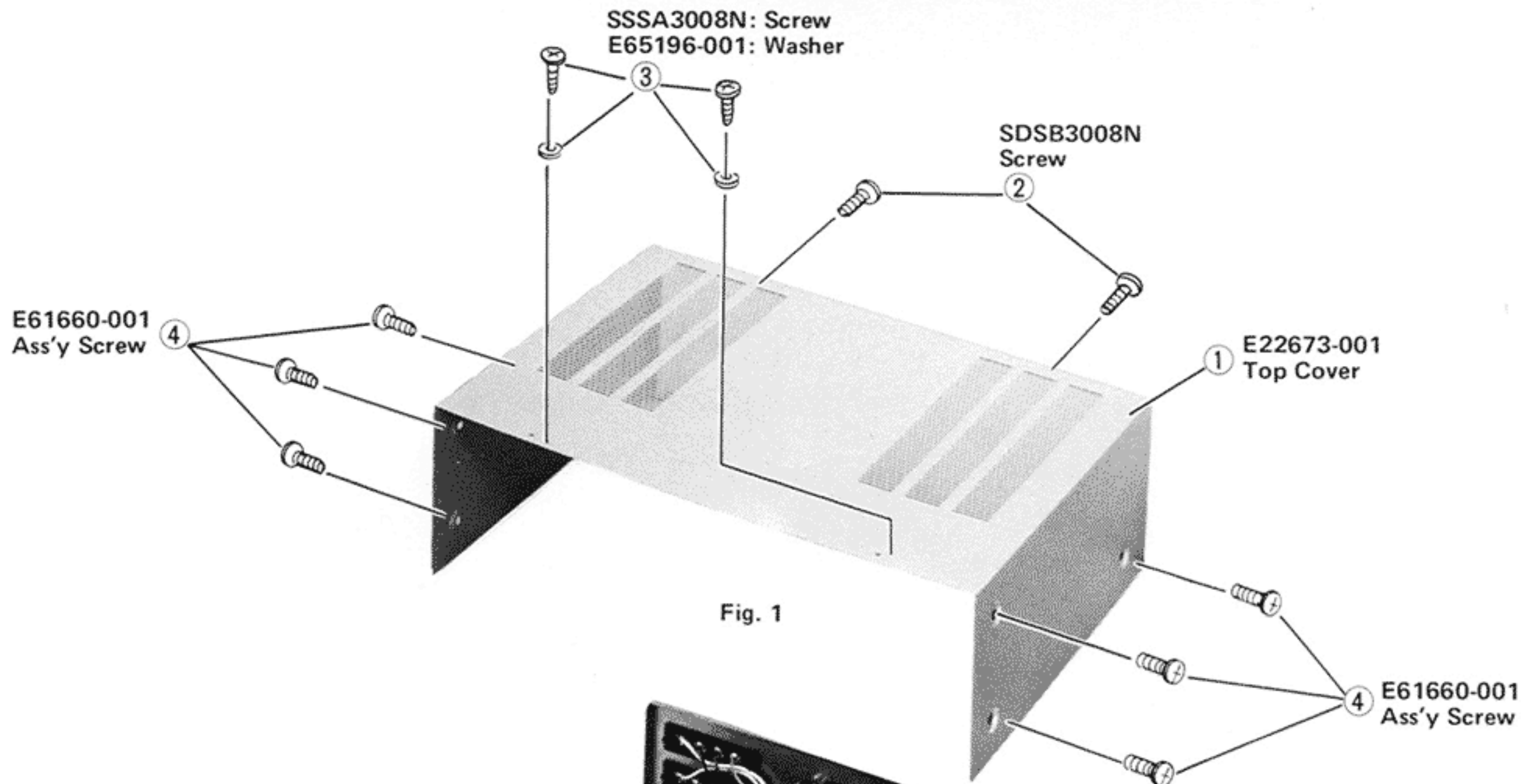

2-(2) Front Panel

Procedures:

1. Remove the top cover. Refer to the Removal of Top Cover on the page 3.
2. Pull out the knobs item no. 1 through no. 7 carefully. Refer to Fig. 4.
3. Remove three screws item no. 10 located on the bottom of the front panel. Refer to Fig. 6.
4. Remove two screws item no. 11 located on the top of front panel. Refer to Fig. 5.
5. Pull out the front panel carefully.

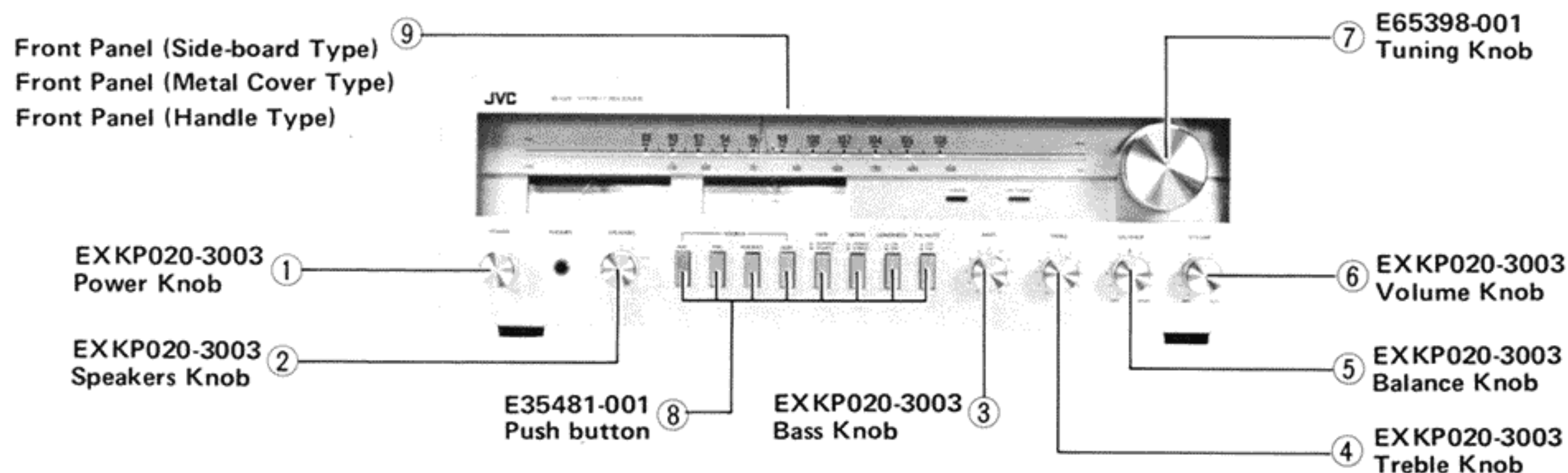

Fig. 4

3. Main Part Locations and Part Numbers

Top View

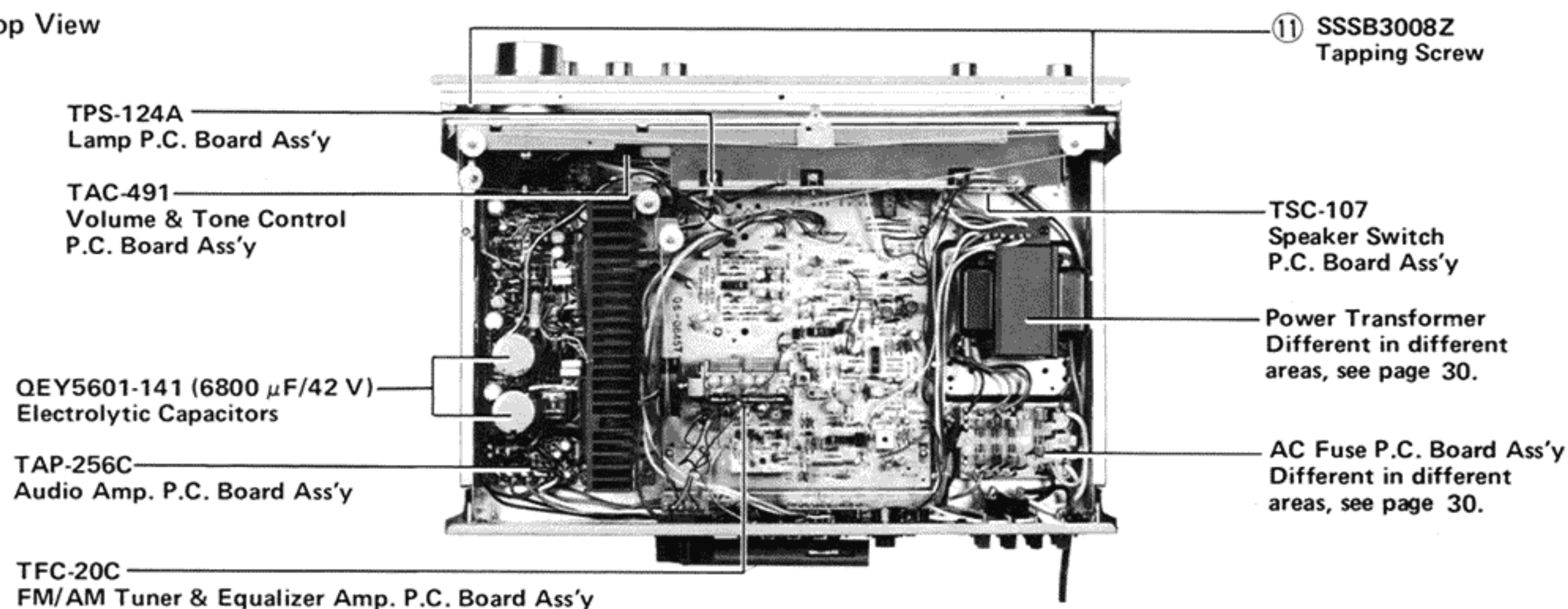

Fig. 5

Bottom View

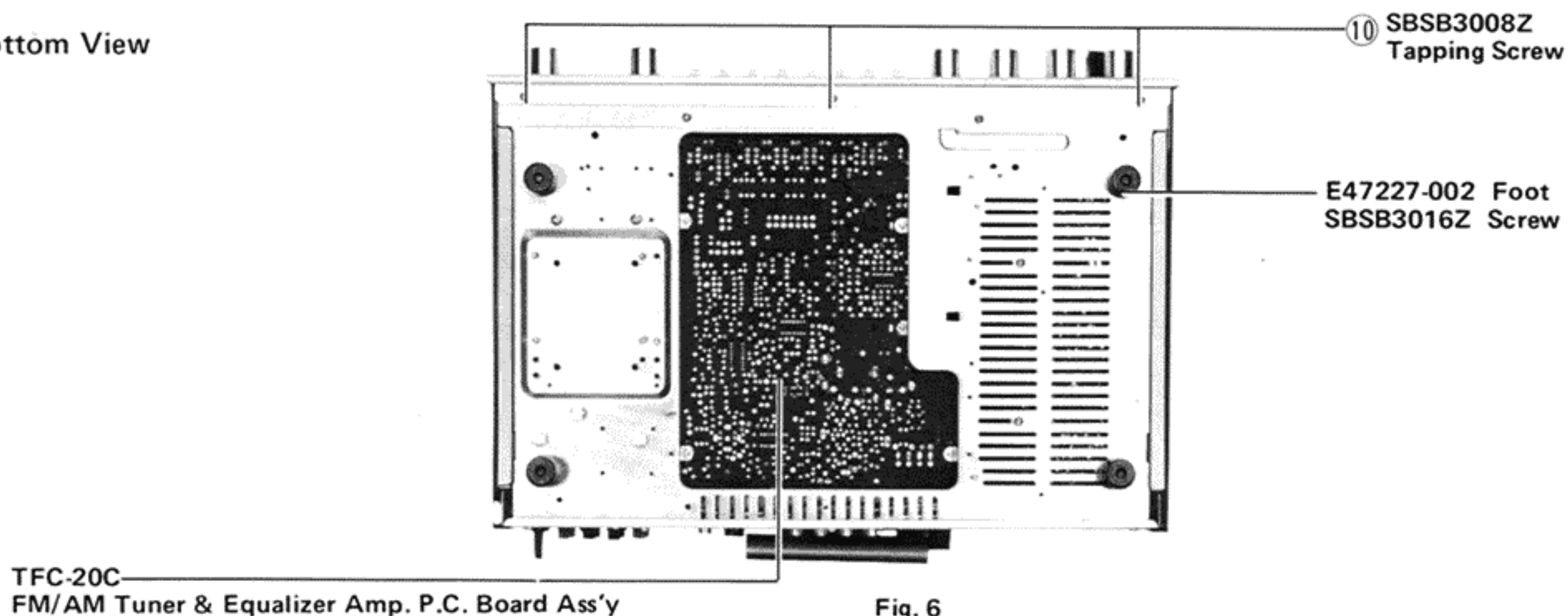

Fig. 6

4. Exploded Views and Part Numbers

4-(1) Front Panel

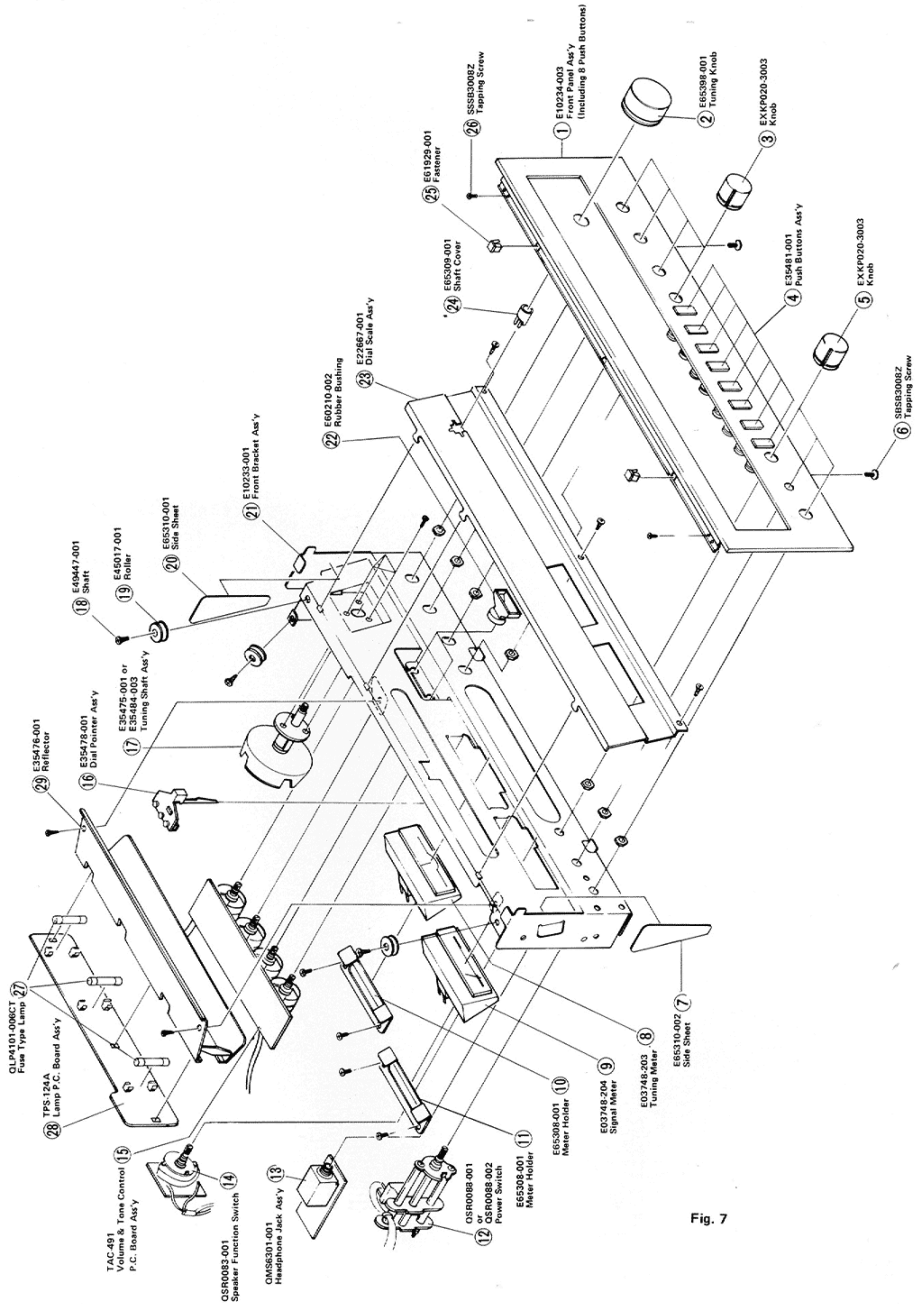

Fig. 7

JR-S81H

JR-S81W

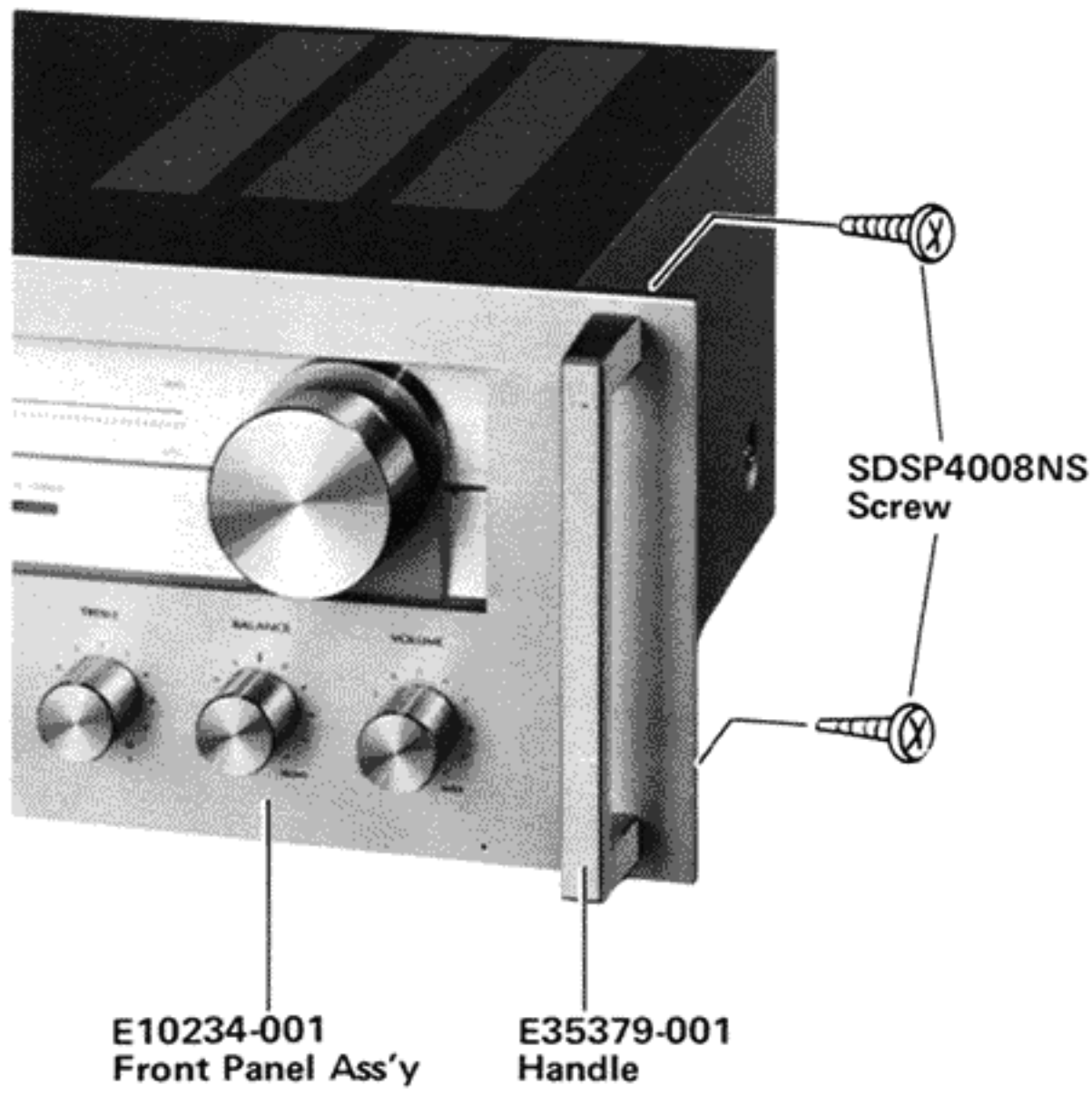

Fig. 8

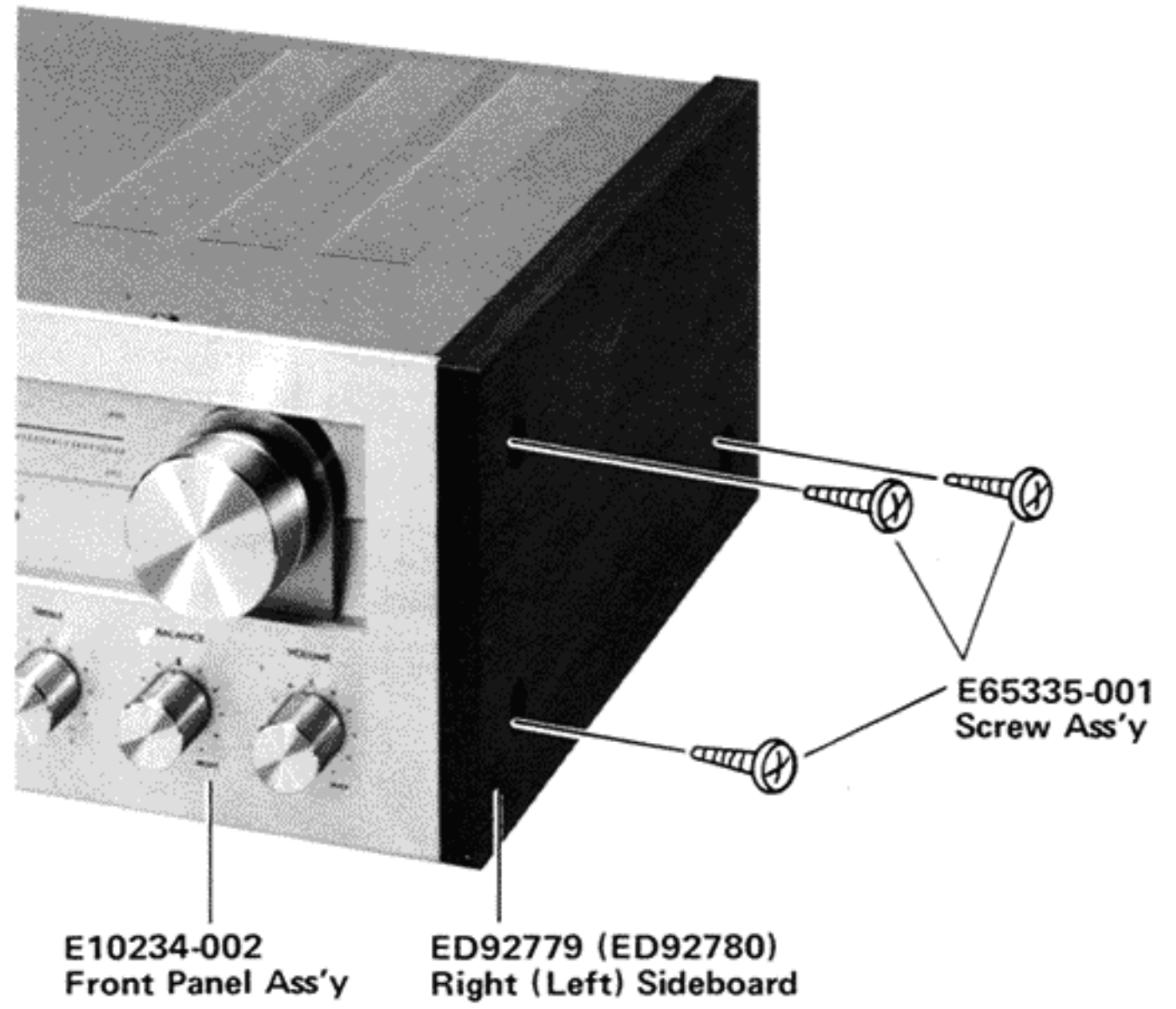

Fig. 9

4-(2) RearPanel

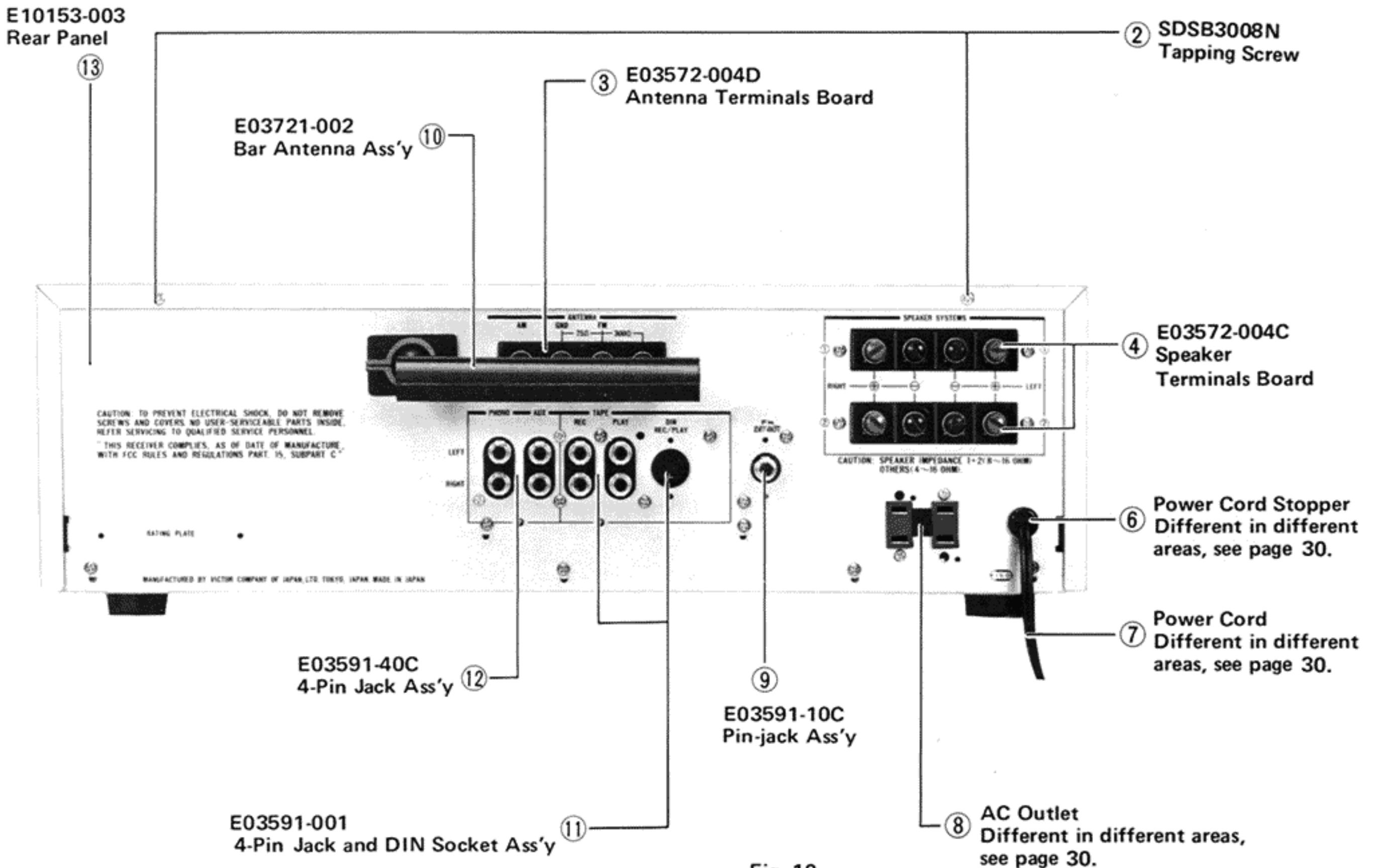

Fig. 10

5. Dial Stringing Procedure

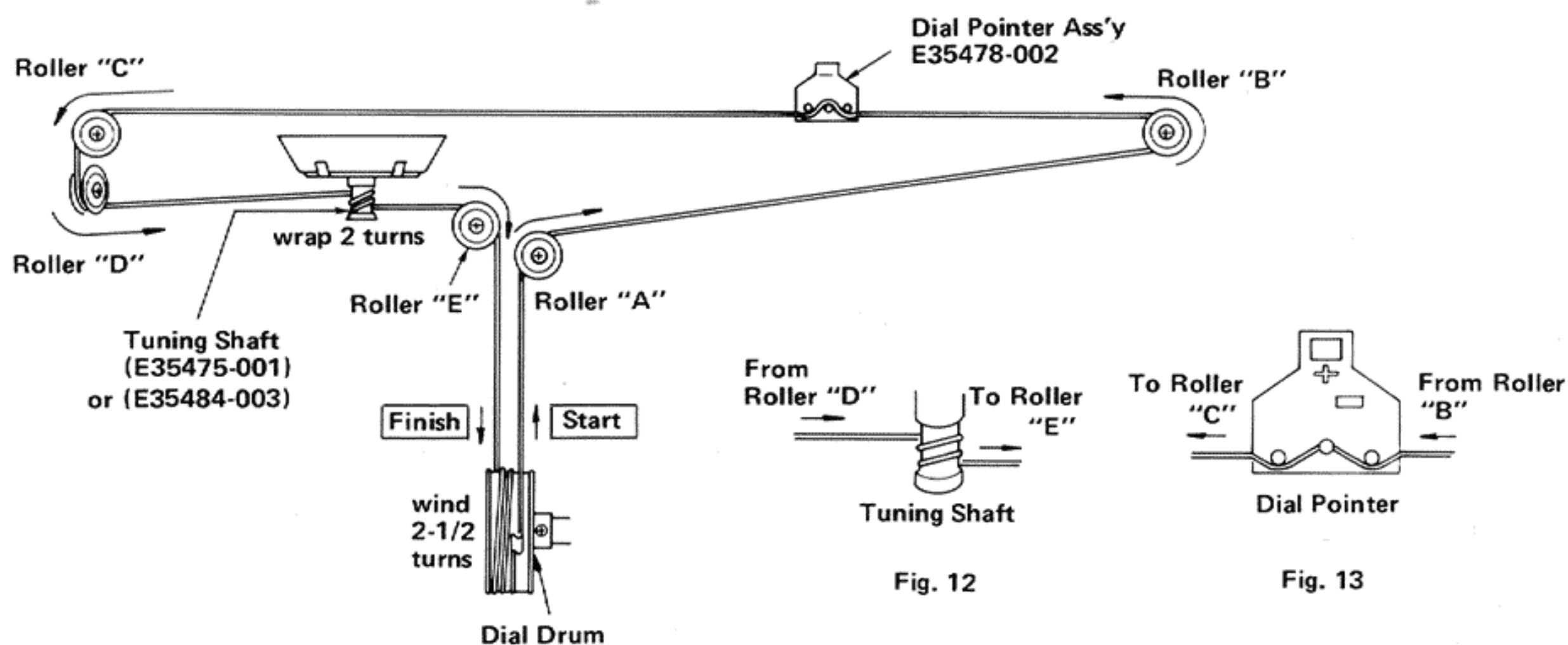

Fig. 11

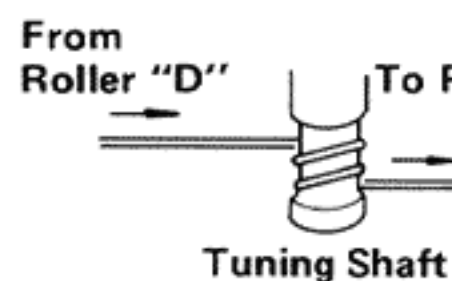

Fig. 12

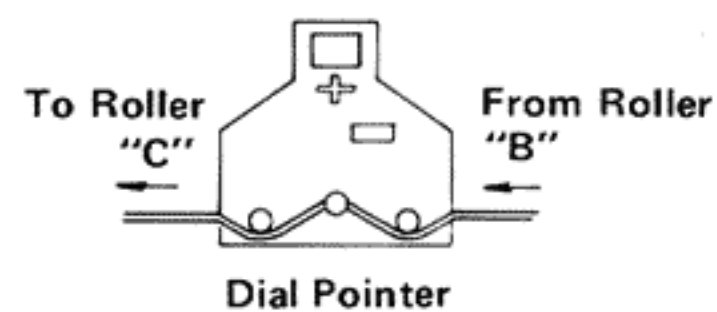

Fig. 13

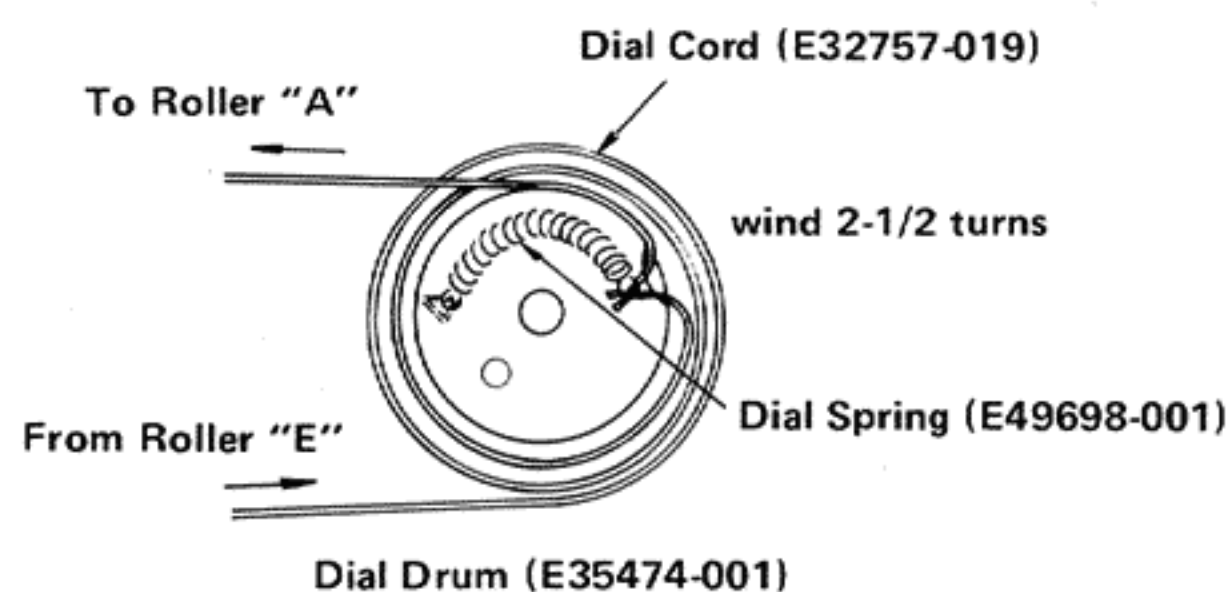

Fig. 14

Procedure:

- (1) Remove a heatsink and an Audio Amp. P.C.Board Ass'y (TAP-256C), see page 8.
- (2) Remove the dial pointer and old dial cord.
- (3) Tie end of new dial cord to one end of dial spring, connect other end of dial spring of bottom right eye inside dial drum, see Fig. 14.
- (4) Rotate the tuning capacitor dial drum to it's maximum counterclockwise.
- (5) Run the dial cord through the slot in the rim of dial drum.
- (6) Guide dial cord under and around rollers A, B, C and D. Keep the dial cord taut during this procedures.
- (7) Pull dial cord taut and wrap 2 turns counterclockwise around tuning shaft. Refer to Fig. 12.
- (8) Guide dial cord around roller E.
- (9) Guide dial cord under and around the dial drum and wind 2-1/2 turns counterclockwise, see Fig. 14.
- (10) Turn the tuning shaft to rotate the dial drum fully counterclockwise and fully clockwise to distribute the tensioning along the dial cord.
- (11) Place the dial cord over and under the tabs on the rear of the dial pointer and place the dial pointer on the top of the dial panel rail. Refer to Fig. 13.
- (12) Turn the tuning shaft clockwise. Slide the dial pointer to ZERO (0) calibration marker on the logging scale while holding tuning shaft fully clockwise. Cement the dial pointer to the dial cord to prevent the slippage. Allow cement to dry thoroughly.
- (13) Check the dial calibration. Refer to FM/AM Alignment Procedures on page 9.

Removing the heat sink and audio amp P.C. board ass'y (TAP-256C)

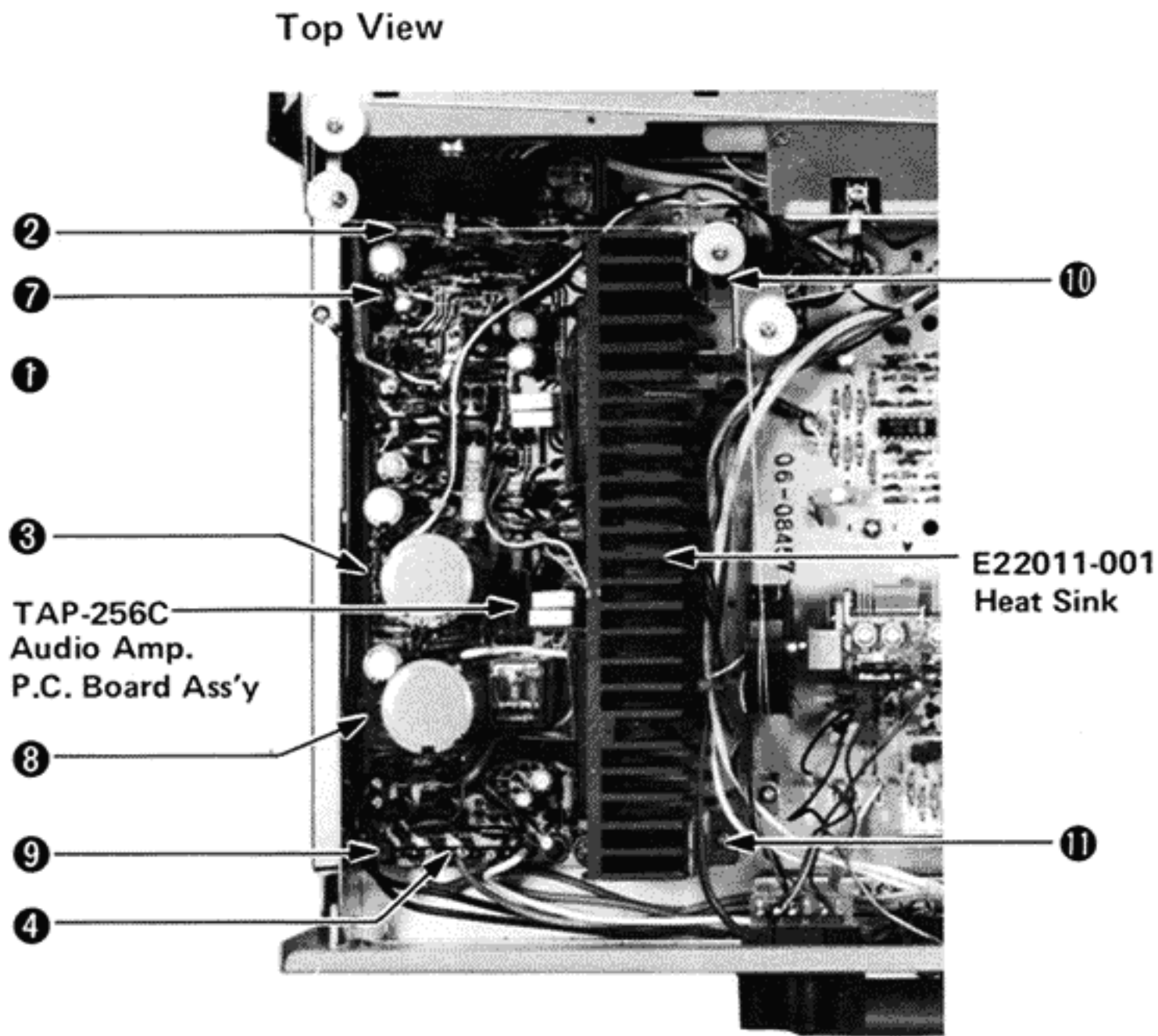

Fig. 15

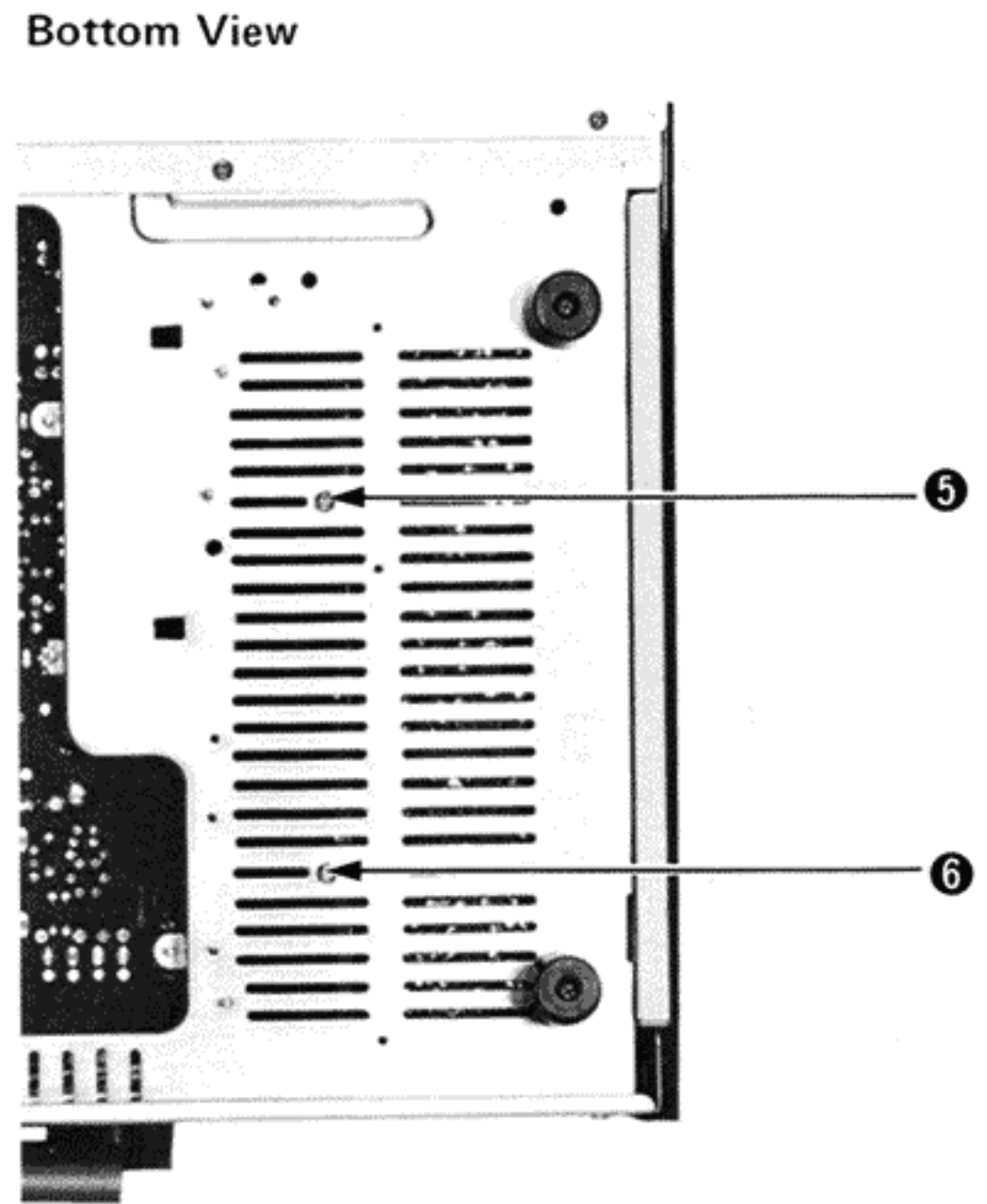

Fig. 16

Procedure: Remove plugs and screws according to the steps below:

Step 1: 4 plugs (Item No. 1 through No. 4)

Step 2: 2 screws (Item No. 5 & 6)

Step 3: 5 screws (Item No. 7 through No. 11)

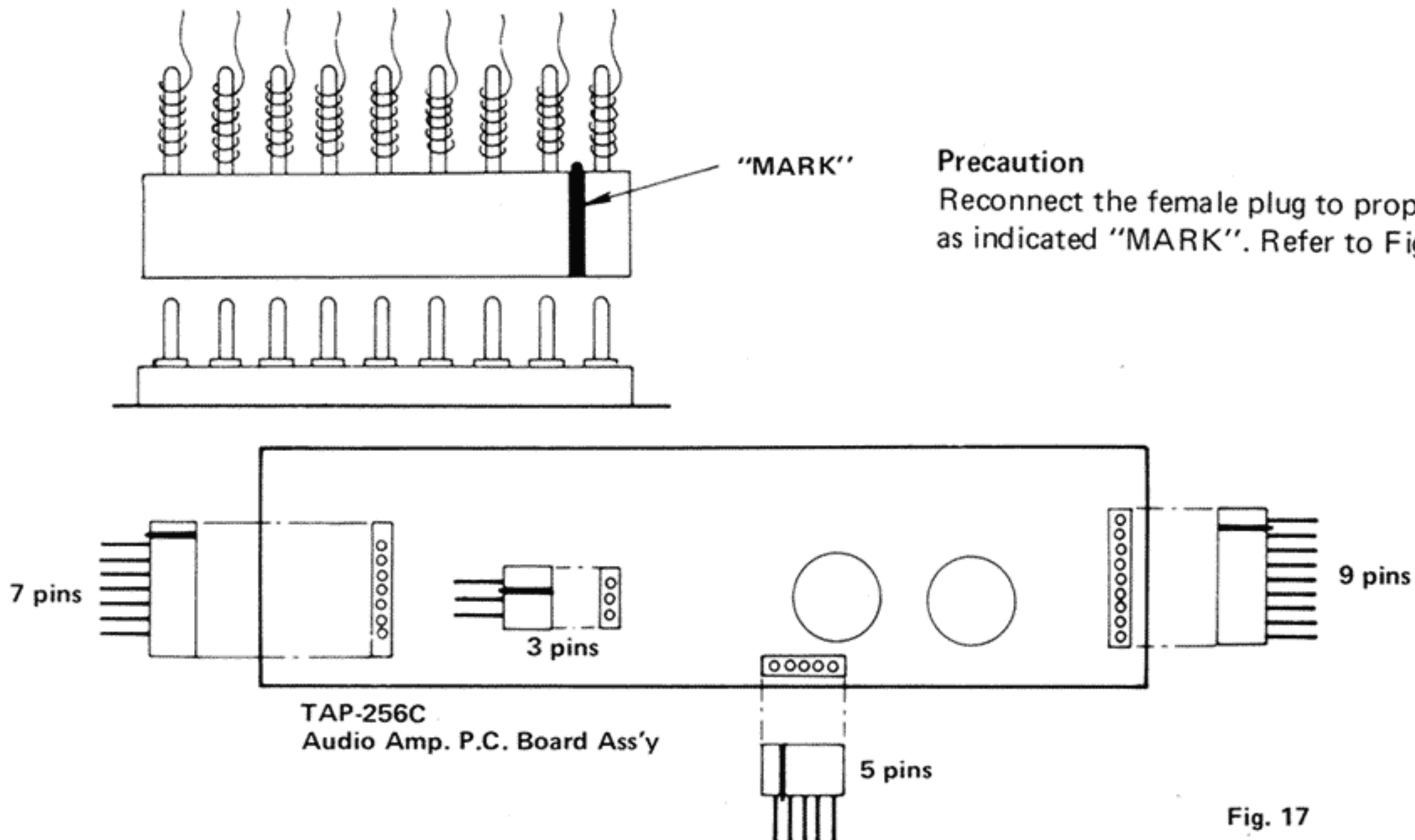

Fig. 17

6. FM/AM Tuner Alignment Procedures

TFC-20 FM/AM Tuner & Equalizer Amp. P.C. Board Ass'y

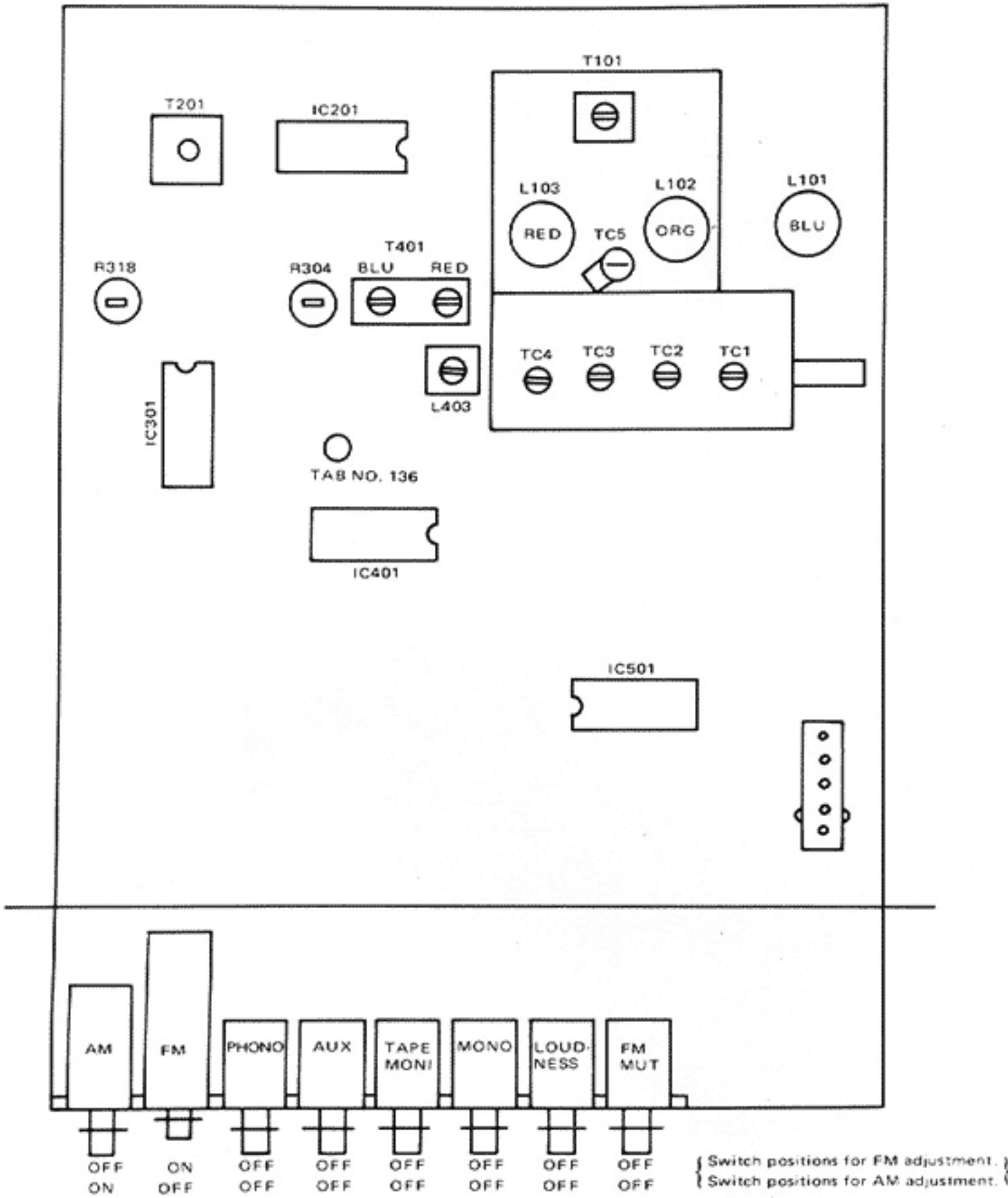

Fig. 18

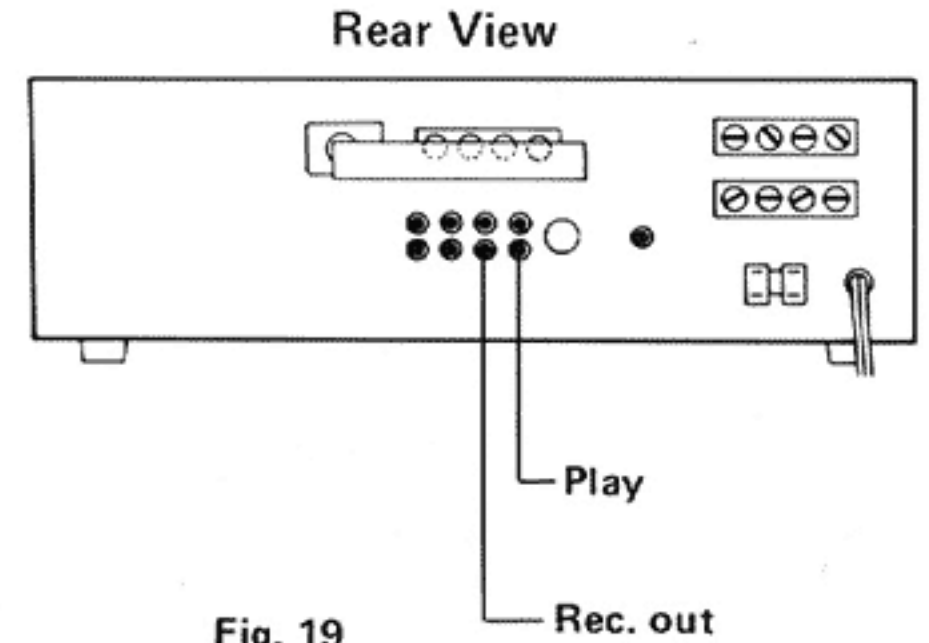

Fig. 19

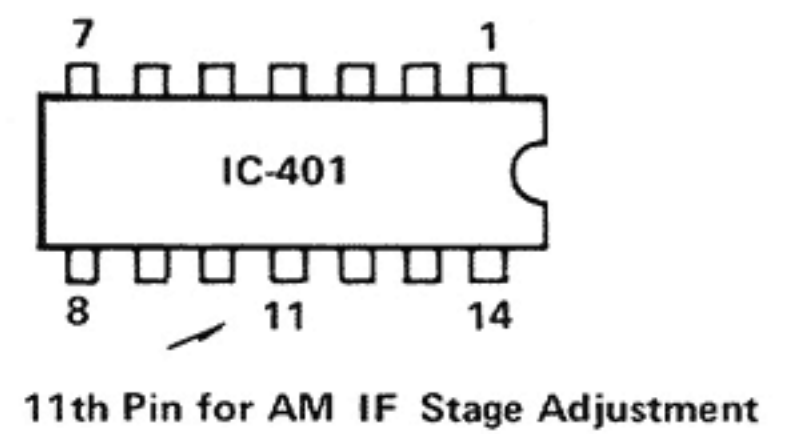

Fig. 20

6-(1) FM Section

Discriminator, Center Meter, Distortion and Signal Gain

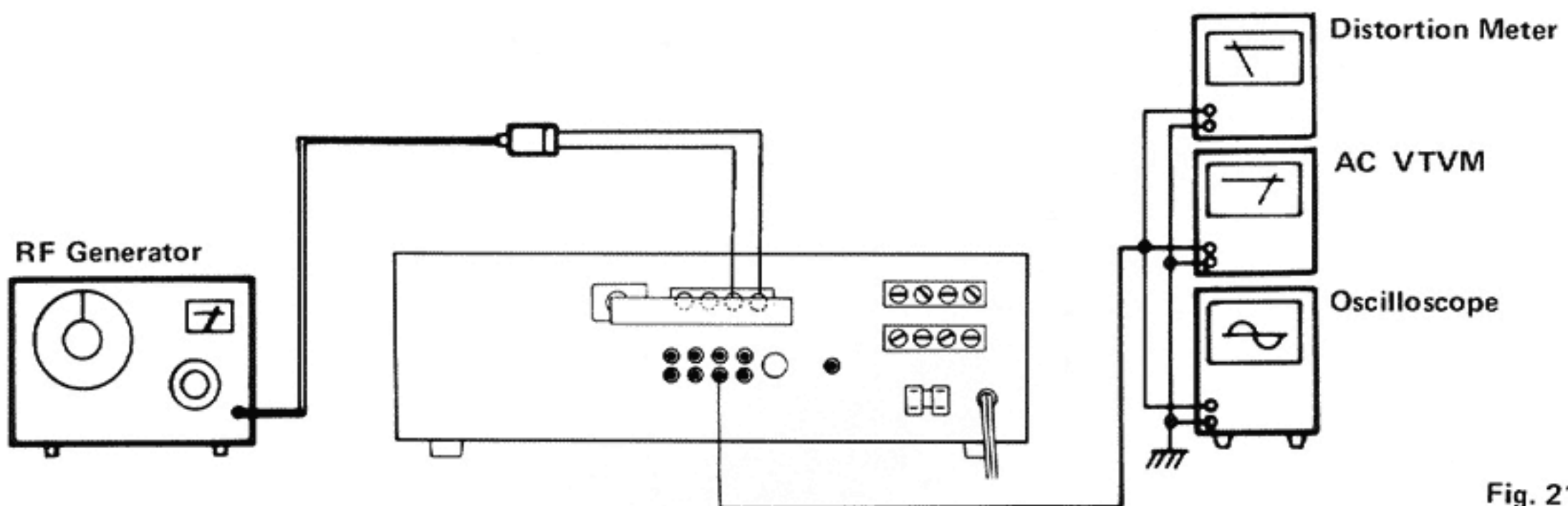

Fig. 21

1. Connect an RF generator, 1 kHz modulation and 75 kHz deviation, to the antenna terminals on the rear panel through a dummy antenna.
2. Connect an oscilloscope, distortion meter and VTVM to the Rec. Out Jacks on the rear panel.
3. Tune to a frequency where there is no broadcasting.
4. Adjust the bottom core of T201 so that the center meter indicates "0" (zero).
5. Set the generator to 98 MHz.
6. Set the dial pointer to 98 MHz.
7. Adjust the top core of T201 so that the distortion is minimized at a value less than 0.4 %.

Tracking and Sensitivity

Precaution: No adjustment is required. The tracking and sensitivity has been adjusted properly and completely at the factory. If any special reason occasioned, take the following procedures very carefully:

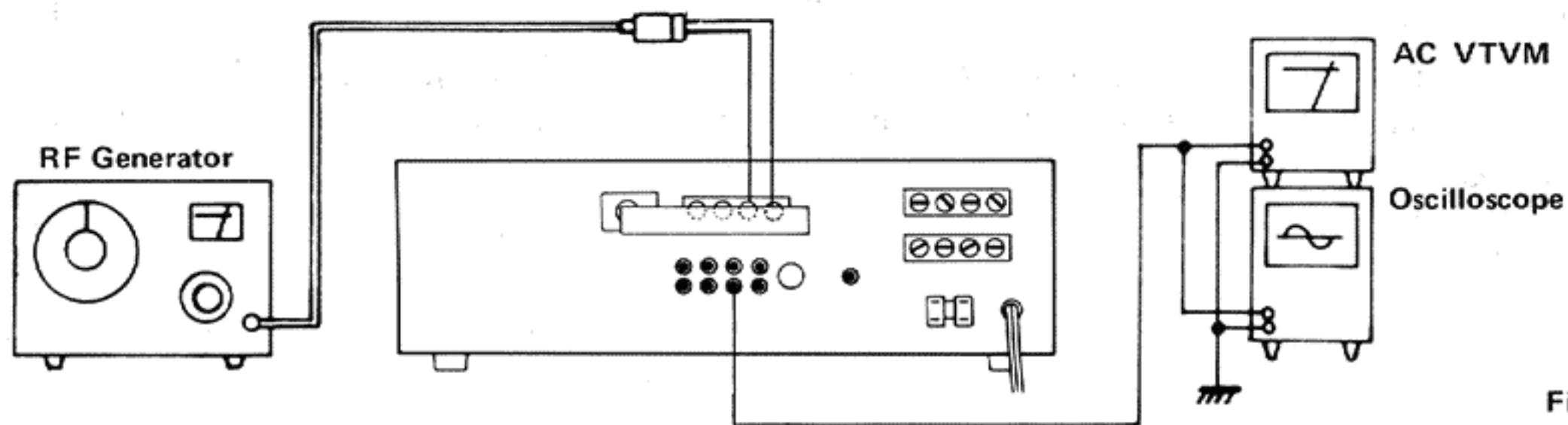

Fig. 22

Low Frequency

1. Connect an RF generator to the antenna terminals on the rear panel through a dummy antenna.
2. Set the RF generator to 88 MHz, a modulation of 1 kHz and a deviation of 75 kHz, to provide an input of $2 \mu\text{V}$.
3. Connect a VTVM and an oscilloscope to the Rec. Out Jacks on the rear panel.
4. Set the dial pointer to 88 MHz.
5. Adjust three coils L103, L102 and L101 in the tuning gang to maximize the output.

High Frequency

6. Set the RF generator to 108 MHz, a modulation of 1 kHz and a deviation of 75 kHz, to provide an input of $2 \mu\text{V}$.
7. Set the dial pointer to 108 MHz.
8. Adjust the FM trimmers TC5, TC3 and TC1 in the tuning gang to maximize the output.
9. Repeat these high and low frequency adjustments alternately until maximum sensitivity is obtained.

Multiplex and Stereo Separation

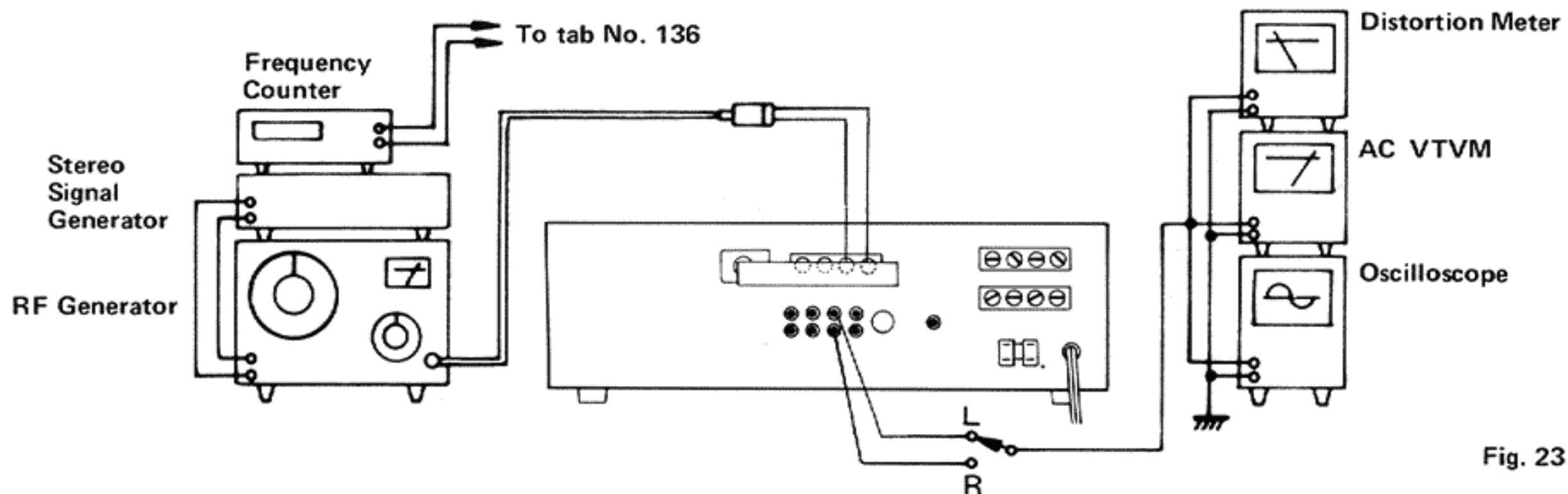

Fig. 23

Multiplex

1. Set a stereo signal generator as follows: Modulation frequency 1 kHz, Deviation pilot 7.5 kHz, Main and Sub. 67.5 kHz. Connect its output to an RF generator.
2. Connect the RF generator to the antenna terminals through a dummy antenna.
3. Connect a VTVM, an oscilloscope and a distortion meter to the Rec. Out Jacks.
4. Set the RF generator to 98 MHz and an output of 1 mV.
5. Set the dial pointer to 98 MHz.
6. Connect a frequency counter to Tab No. 136.
7. Switch off the pilot signal of the stereo modulator.
8. Adjust R304 so that the frequency counter indicates 76 kHz (± 0.05 kHz).

Stereo Separation

9. Switch the selector of the stereo modulator to left channel modulation.
10. Adjust R318 so that the output of the right channel is minimized.
11. Switch the selector of the modulator to right channel modulation.
12. Adjust R318 so that the output of the left channel is minimized.
13. Set R318 to average, if the separation of right and left are different.

Note: Keep the "MONO" push button out during this adjustment procedure of stereo separation.

6-(2) AM Section

IF Stage

1. Connect an output of sweep generator to the AM input Tab No. 113.
2. Set the sweep generator to 455 kHz.
3. Connect an input of sweep generator to the AM output (11th Pin of IC401). Refer to Fig. 29.
4. Adjust the blue and red cores of I.F. Transformer T401 so that the output is maximized. Refer to Fig. 24.

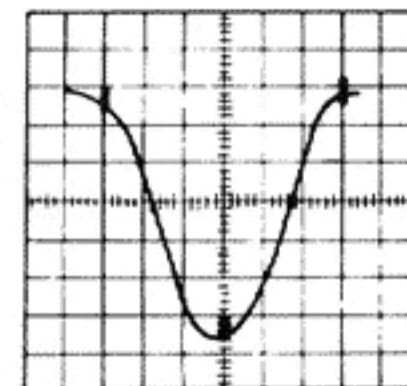

Tracking and Sensitivity

Low Frequency

1. Connect an RF generator to the antenna terminals on the rear panel, set this to 600 kHz with 30 % modulation at 400 Hz.
2. Connect an AC VTVM and an oscilloscope to Rec. Out Jacks on the rear panel.
3. Set the dial pointer to 600 kHz.
4. Adjust Osc. transformer L403 and the ferrite bar antenna to maximize the output signal.

High Frequency

5. Set the RF generator to 1 400 kHz with 30 % modulation at 400 Hz.
6. Set the dial pointer to 1 400 kHz.
7. Adjust the trimmers TC4 and TC2 in the AM tuning gang so that the output signal is maximized.
8. Repeat these high and low frequency adjustments alternately until maximum sensitivity is obtained.

7. Printed Circuit Board Ass'y and Parts List

7-(1) TFC-20C FM/AM Tuner & Equalizer Amp. P.C. Board Ass'y

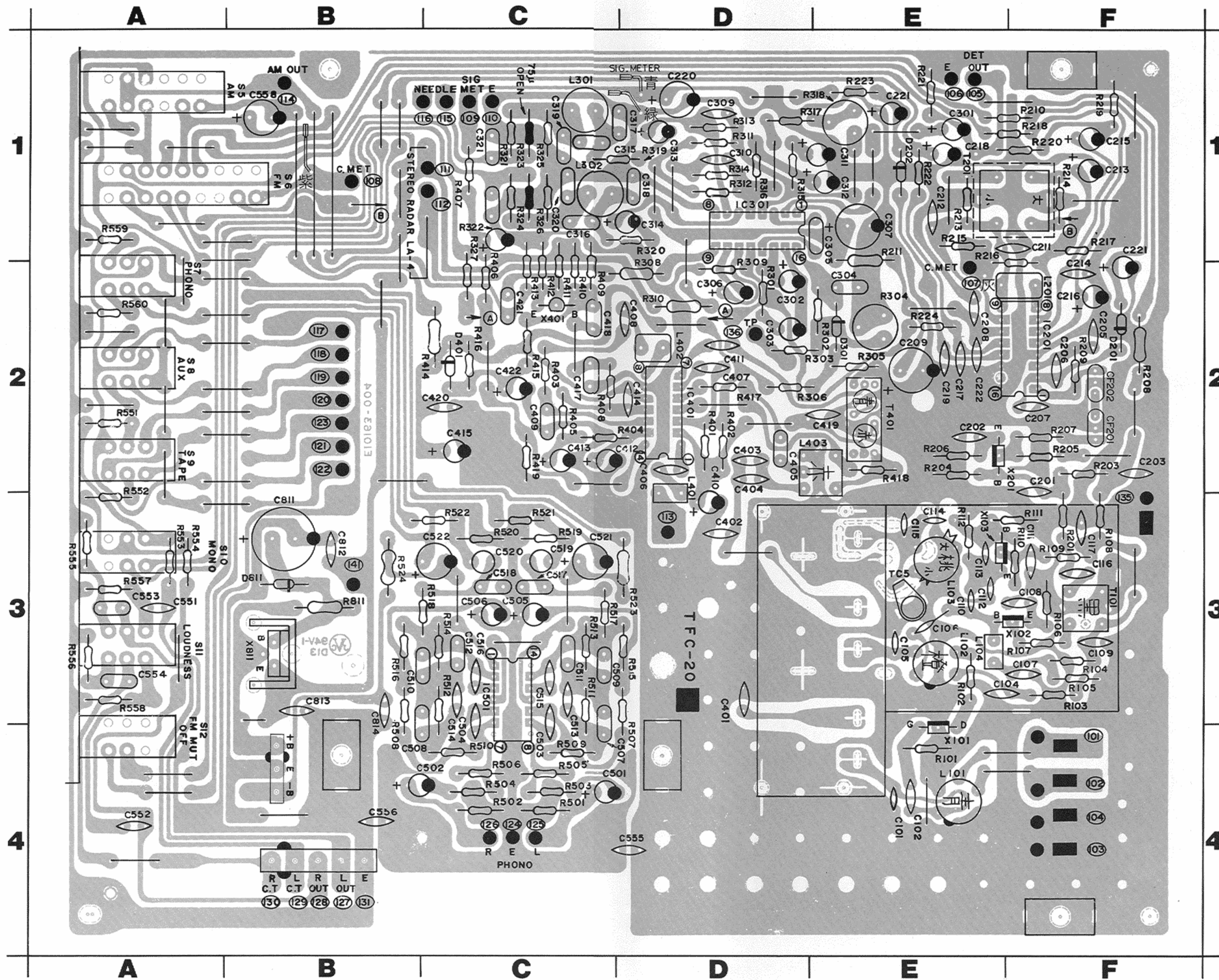

Fig. 25

Transistors

Item No.	Part Number	Rating		Description	Maker
		P _c	f _T		
X101	2SK55 (D)	IDSS: 14 mA, NF: 3.5 dB (f=100 MHz)		FE Transistor	Hitachi
X102	2SC535 (B, C)	100 mW	700 MHz	Silicon Transistor	"
X103	2SC1342 (B, C)	"	250 MHz	"	"
X201	2SC535 (C)	"	700 MHz	"	"
X401	2SC458 (C)	250 mW	"	"	"

Integrated Circuits

Item No.	Part Number	Rating		Description	Maker
		P _c	f _T		
IC201	HA1137W	500 mW		Integrated Circuit FM IF DET	Hitachi
IC301	HA1196	490 mW		" MPX	"
IC401	HA1151	500 mW		" AM IF DET	"
IC501	HA1452W	540 mW		" Equalizer	"

Diodes

Item No.	Part Number	Rating		Description	Maker
		P _c	f _T		
D201	1S2473			Silicon	Toyo Dengu
D202	1S2473			"	"
D301	1S2473			"	"
D401	1S2473			"	"

Coils & Transformers

Item No.	Part Number	Rating		Description
		P _c	f _T	
L101	E03477-024			RF Coil
L102	E03477-35			"
L103	E03477-026			"
L104	E03522-2R2KY	2.2 μ H		Choke Coil
L201	E03522-220K	22 μ H		"
L301	E03587-103	0.01 μ H		Coil
L302	E03587-103	"		"
L401	E03522-2R2KY	2.2 μ H		Choke Coil
L402	E03522-391KY	390 μ H		"
L403	E03079-29			AM CSC Coil
T101	E03078-39			I.F. Transformer
T201	E03134-025			FM DET Transformer
T401	E03613-002			AM I.F. Transformer

Capacitors

Item No.	Part Number	Rating		Description
C101	QCS31HJ-180	18 pF	50 V	Ceramic
C102	QCS31HJ-101	100 pF	"	"
C104	QCF31HP-103U	0.01 μ F	"	"
C105	QCS31HJ-180	18 pF	"	"
C106	QCS31HJ-4R0	4 pF	"	"
C107	QCS31HJ-101	100 pF	"	"
C108	QCF31HP-103U	0.01 μ F	"	"
C109	QCF31HP-103U	"	"	"
C110	QCS31HJ-4R0	4 pF	"	"
C111	QCF31HP-103U	0.01 μ F	"	"
C112	QCT05CH-100	10 pF	"	"
C113	QCT05CH-220	22 pF	"	"
C114	QCT05CH-7R0	7 pF	"	"
C115	QCT05SH-220	22 pF	"	"
C116	QCF31HP-223	0.022 μ F	"	"
C117	QCF31HP-223	"	"	"
C202	QCF31HP-223Z	0.022 μ F	"	"
C203	QCF31HP-223Z	"	"	"
C205	QCZ0107-473	0.047 μ F	"	"
C206	QCZ0107-473	"	"	"
C207	QCZ0107-473	"	"	"
C208	QCF31HP-223Z	0.022 μ F	"	"
C209	QEW51CA-107	100 μ F	16 V	Electrolytic
C211	QCT05CH-150	15 pF	50 V	Ceramic
C212	QCF31HP-223Z	0.022 μ F	"	"
C213	QEW51HA-105Z	1 μ F	"	Electrolytic
C214	QCS31HJ-330Z	33 pF	"	Ceramic
C215	QEW51EA-475	4.7 μ F	25 V	Electrolytic
C216	QEW51EA-475	"	"	"
C217	QCF31HP-223	0.022 μ F	50 V	Ceramic
C218	QEW51HA-105Z	1 μ F	"	Electrolytic
C219	QCF31HP-223	0.022 μ F	"	Ceramic
C220	QEW51AA-227	220 μ F	10 V	Electrolytic
C301	QEW51HA-225	2.2 μ F	50 V	"
C302	QEB51AM-225	"	25 V	L.L.C. Electrolytic
C303	QEB51EM-335	3.3 μ F	"	"
C304	QFP31HJ-361	360 pF	50 V	Plastic Film
C305	QFM51HK-473	0.047 μ F	"	Mylar
C306	QEB51HM-224	0.22 μ F	"	L.L.C. Electrolytic
C307	QEW51CA-227	220 μ F	16 V	Electrolytic
C309	QCS31HJ-471	470 pF	50 V	Ceramic
C310	QCS31HJ-471	"	"	"
C311	QEW51CA-106	10 μ F	16 V	Electrolytic
C312	QEW51CA-106	"	"	"
C313	QEW51HA-225	2.2 μ F	50 V	"
C314	QEW51HA-225	"	"	"
C315	QFM51HK-682	6800 pF	"	Mylar
C316	QFM51HK-682	"	"	"
C317	QFM51HK-822	8200 pF	"	"
C318	QFM51HK-822	"	"	"
C319	QFM51HK-273	0.027 μ F	"	"
C320	QFM51HK-273	"	"	"
C321	QFM51HK-822	8200 pF	"	"
C322	QFM51HK-822	"	"	"

Capacitors

Item No.	Part Number	Rating		Description
C401	QCS31HJ-5R0	5 pF	50 V	Ceramic
C402	QCS31HJ-150	15 pF	"	"
C403	QCS31HJ-331	330 pF	"	"
C404	QCS31HJ-150	15 pF	"	"
C405	QFM51HK-103	0.01 μ F	"	Mylar
C406	QCF31HP-223	0.022 μ F	"	Ceramic
C407	QCF31HP-223	"	"	"
C408	QCS31HJ-331	330 pF	"	"
C409	QFM51HK-102	1000 pF	"	Mylar
C410	QEW51CA-106	10 μ F	16 V	Electrolytic
C411	QCF31HP-223	0.022 μ F	50 V	Ceramic
C412	QEW51EA-106	10 μ F	25 V	Electrolytic
C413	QEW51CA-106	10 μ F	16 V	"
C414	QCF31HP-223	0.022 μ F	50 V	Ceramic
C415	QEW51CA-476	47 μ F	16 V	Electrolytic
C417	QFM51HK-682	6800 pF	50 V	Mylar
C418	QFM51HK-223	0.022 μ F	"	"
C419	QCF31HP-223	0.022 μ F	"	Ceramic
C420	QCF31HP-223	"	"	"
C421	QEW51HA-474	0.47 μ F	"	Electrolytic
C422	QEW51CA-106	10 μ F	16 V	"
C501	QEB51EM-475	4.7 μ F	25 V	L.L.C. Electrolytic
C502	QEB51EM-475	"	"	"
C503	QCS31HJ-101	100 pF	50 V	Ceramic
C504	QCS31HJ-101	"	"	"
C505	QEW51CA-476	47 μ F	16 V	Electrolytic
C506	QEW51CA-476	"	"	"
C507	QFM51HK-182	1800 pF	50 V	Mylar
C508	QFM51HK-182	"	"	"
C509	QFM51HK-682	6800 pF	"	"
C510	QFM51HK-682	"	"	"
C513	QCS31HJ-820	82 pF	"	Ceramic
C514	QCS31HJ-820	"	"	"
C515	QCS31HJ-151	150 pF	"	"
C516	QCS31HJ-151	"	"	"
C517	QFM51HK-332	3300 pF	"	Mylar
C518	QFM51HK-332	"	"	"
C519	QEZ0046-105	1 μ F	"	Electrolytic
C520	QEZ0046-105	"	"	"
C521	QEW51CA-476	47 μ F	16 V	"
C522	QEW51CA-476	"	"	"
C551	QCS31HJ-331	330 pF	50 V	Ceramic
C552	QCS31HJ-331	"	"	"
C553	QFM51HK-273	0.027 μ F	"	Mylar
C554	QFM51HK-273	"	"	"
C555	QCF51HP-223	0.022 μ F	"	Ceramic
C222	QCF51HP-223	"	"	"
C812	QCF51HP-103	0.01 μ F	"	"
C813	QCF51HP-223	0.022 μ F	"	"
C814	QCF51HP-223	"	"	"
TC5	QAT3001-005			Trimmer

Resistors

Item No.	Part Number	Rating		Description
R101	QRD 141J-105S	1 M Ω	1/4 W	Carbon
R102	QRD 141J-470S	47 Ω	"	"
R103	QRD 141J-101S	100 Ω	"	"
R104	QRD 141J-223S	22 k Ω	"	"
R105	QRD141J-562S	5.6 k Ω	"	"
R106	QRD 141J-102S	1 k Ω	"	"
R107	QRD 141J-101S	100 Ω	"	"
R108	QRD 141J-470S	47 Ω	"	"
R109	QRD 141J-561S	560 Ω	"	"
R110	QRD 141J-103S	10 k Ω	"	"
R111	QRD 141J-103S	"	"	"
R112	QRD 141J-222S	2.2 k Ω	"	"
R203	QRD 141J-332S	3.3 k Ω	"	"
R204	QRD 141J-821S	820 Ω	"	"
R205	QRD 141J-331S	330 Ω	"	"
R206	QRD 141J-102S	1 k Ω	"	"
R207	QRD 141J-470S	47 Ω	"	"
R208	QRD 126J-220	22 Ω	1/2 W	Uninflammable Carbon
R209	QRD 141J-331S	330 Ω	1/4 W	Carbon
R210	QRD 141J-474S	470 k Ω	"	"
R211	QRD 126J-100	10 Ω	1/2 W	Uninflammable Carbon
R213	QRD 141J-562S	5.6 k Ω	1/4 W	Carbon
R214	QRD 141J-432S	4.3 k Ω	"	"
R215	QRD 141J-682S	6.8 k Ω	"	"
R216	QRD 141J-271S	270 Ω	"	"
R218	QRD 141J-123S	12 k Ω	"	"
R220	QRD 141J-472S	4.7 k Ω	"	"
R221	QRD 141J-153S	15 k Ω	"	"
R222	QRD 141J-472S	4.7 k Ω	"	"
R223	QRD 141J-153S	15 k Ω	"	"
R224	QRD 141J-104S	100 k Ω	"	"
R301	QRD 141J-102S	1 k Ω	"	"
R302	QRD 141J-223S	22 k Ω	"	"
R303	QRD 141J-104S	100 k Ω	"	"
R304	QVP4A0B-103	10 k Ω	"	Variable
R305	QRD 141J-103S	"	1/4 W	Carbon
R306	QRD 141J-103S	"	"	"
R308	QRD 126J-181	180 Ω	1/2 W	"
R309	QRD 141J-104S	100 k Ω	1/4 W	"
R310	QRD 126J-100	10 Ω	1/2 W	Uninflammable Carbon
R311	QRD 141J-303S	30 k Ω	1/4 W	Carbon
R312	QRD 141J-303S	"	"	"
R313	QRD 141J-473S	47 k Ω	"	"
R314	QRD 141J-473S	"	"	"
R315	QRD 141J-103S	10 k Ω	"	"
R316	QRD 141J-103S	"	"	"
R318	QVP4A0B-474	470 k Ω	"	Variable
R319	QRD 141J-152S	1.5 k Ω	1/4 W	Carbon
R320	QRD 141J-152S	"	"	"
R321	QRD 141J-122S	1.2 k Ω	"	"
R322	QRD 141J-122S	"	"	"
R325	QRD 141J-103S	10 k Ω	"	"
R326	QRD 141J-103S	"	"	"
R327	QRD 141J-474S	470 k Ω	"	"
R401	QRD 141J-472S	4.7 k Ω	"	"

Resistors

Item No.	Part Number	Rating		Description
R402	QRD 141J-151S	150 Ω	1/4 W	Carbon
R403	QRD 141J-331S	330 Ω	"	"
R404	QRD 141J-103S	10 kΩ	"	"
R405	QRD 141J-103S	"	"	"
R406	QRD 141J-152S	1.5 kΩ	"	"
R408	QRD 141J-103S	10 kΩ	"	"
R409	QRD 141J-683S	68 kΩ	"	"
R411	QRD 141J-472S	4.7 kΩ	"	"
R412	QRD 141J-152S	1.5 kΩ	"	"
R413	QRD 141J-473S	47 kΩ	"	"
R414	QRD 126J-101	100 Ω	1/2 W	Uninflammable Carbon
R415	QRD 141J-184S	180 kΩ	1/4 W	Carbon
R416	QRD 141J-333S	33 kΩ	"	"
R501	QRD 141J-104S	100 kΩ	"	"
R502	QRD 141J-104S	"	"	"
R503	QRD 141J-222S	2.2 kΩ	"	"
R504	QRD 141J-222S	"	"	"
R505	QRD 141J-104S	100 kΩ	"	"
R506	QRD 141J-104S	"	"	"
R507	QRD 141J-561S	560 Ω	"	"
R508	QRD 141J-561S	"	"	"
R509	QRD 141J-182S	1.8 kΩ	"	"
R510	QRD 141J-182S	"	"	"
R511	QRD 141J-393S	39 kΩ	"	"
R512	QRD 141J-393S	"	"	"
R513	QRD 141J-474S	470 kΩ	"	"
R514	QRD 141J-474S	"	"	"
R515	QRD 141J-564S	560 kΩ	"	"
R516	QRD 141J-564S	"	"	"
R517	QRD 141J-470S	47 Ω	"	"
R518	QRD 141J-470S	"	"	"
R519	QRD 141J-104S	100 kΩ	"	"
R520	QRD 141J-104S	"	"	"
R523	QRD 126J-100	10 Ω	1/2 W	Uninflammable Carbon
R524	QRD 126J-680	68 Ω	"	"
R551	QRD 141J-332S	3.3 kΩ	1/4 W	Carbon
R552	QRD 141J-332S	"	"	"
R555	QRD 141J-153S	15 kΩ	"	"
R556	QRD 141J-153S	"	"	"
R557	QRD 141J-564S	560 kΩ	"	"
R558	QRD 141J-564S	"	"	"
R559	QRD 141J-471S	470 Ω	"	"
R560	QRD 141J-471S	"	"	"

Others

Item No.	Part Number	Rating	Description
CF201	E60171-003		Heat Sink
CF202	QAA2234-001		Variable Capacitor
	E03357-009		Ceramic Filter
	E03357-009		"

7-(2) TPS-93G AC Fuse P.C. Board Ass'y

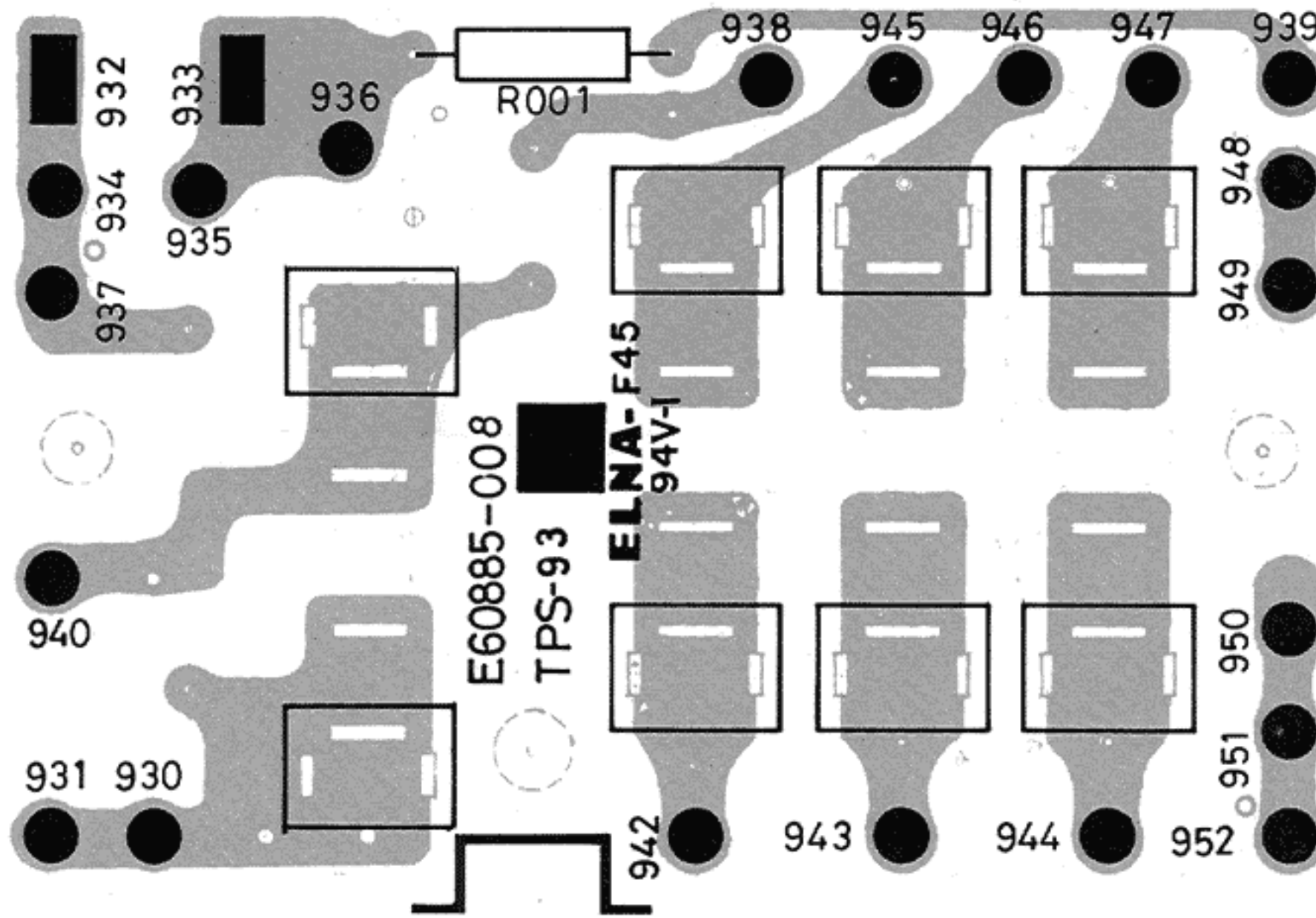

Fig. 26

Note:

Different assemblies are used in units intended for different areas. Make sure of where the unit was sold. Refer to page 30 and the table below.

P.C. Board Ass'y	Item No.	Part Number	Rating		Description
TPS-93G	R911	QRC121K-275E E45524-001	2.7 MΩ	1/2 W	Composition Resistor Contact Clip
TPS-93H	R911	QRC121K-475E E45524-001	4.7 MΩ	1/2 W	Composition Resistor Contact Clip
TPS-93I		E48965-002			Contact Clip
TPS-93IBS		E48965-002BS			Contact Clip
TPS-93J	R911	QRC121K-275E E45524-001	2.7 MΩ	1/2 W	Composition Resistor Contact Clip

7-(3) TSC-107 Speaker Switch P.C. Board Ass'y

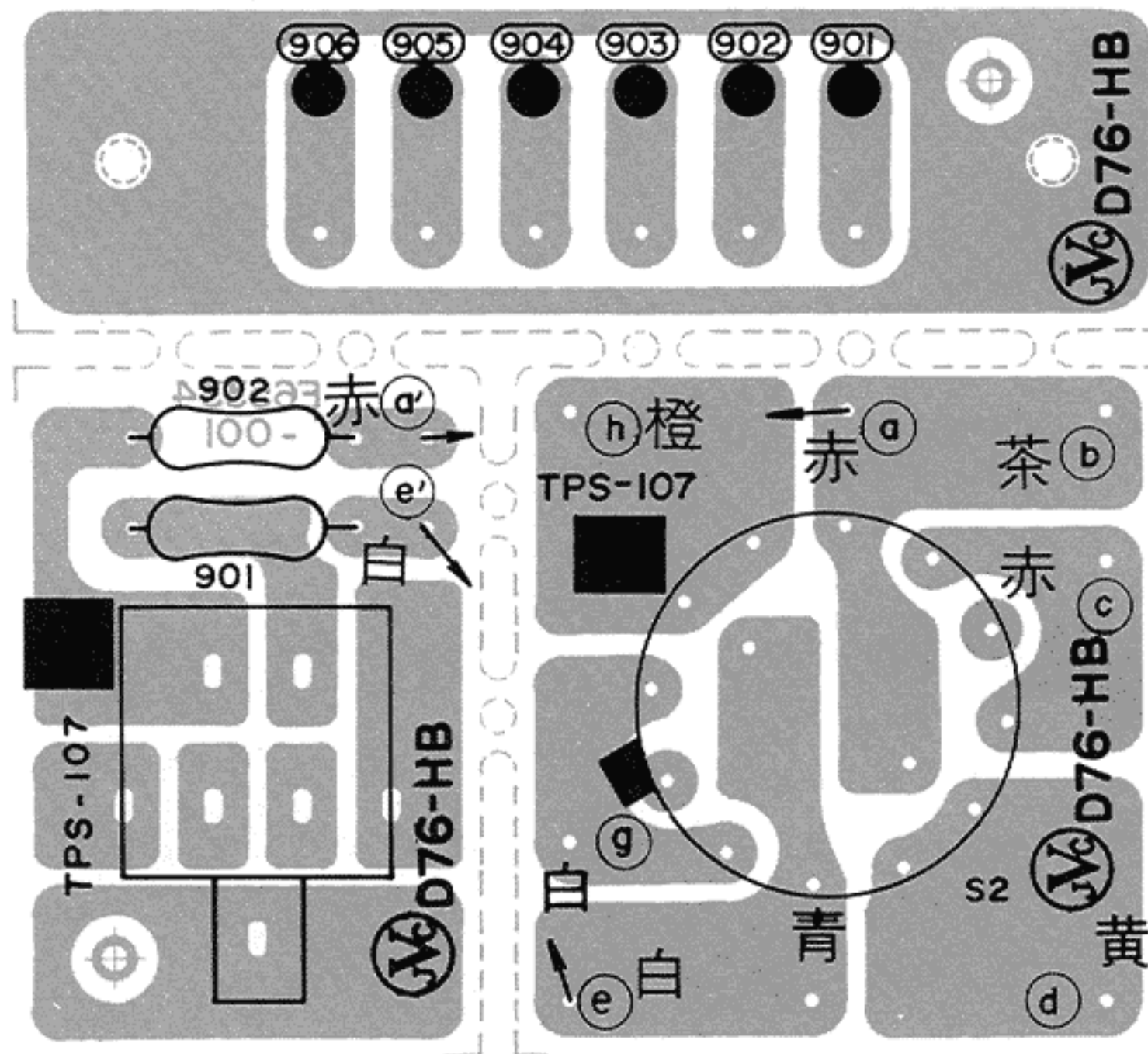

Fig. 27

Resistors

Item No.	Part Number	Rating		Description
R901	QRD126J-221	220 Ω	1/2 W	Uninflammable Carbon
R902	QRD126J-221	"	1/2 W	"

Others

Item No.	Part Number	Rating	Description
	QSR0083-001		Speaker Function Switch
	QMS6312-002		Headphones Jack Ass'y

7-(4) TPS-124A Lamp P.C. Board Ass'y

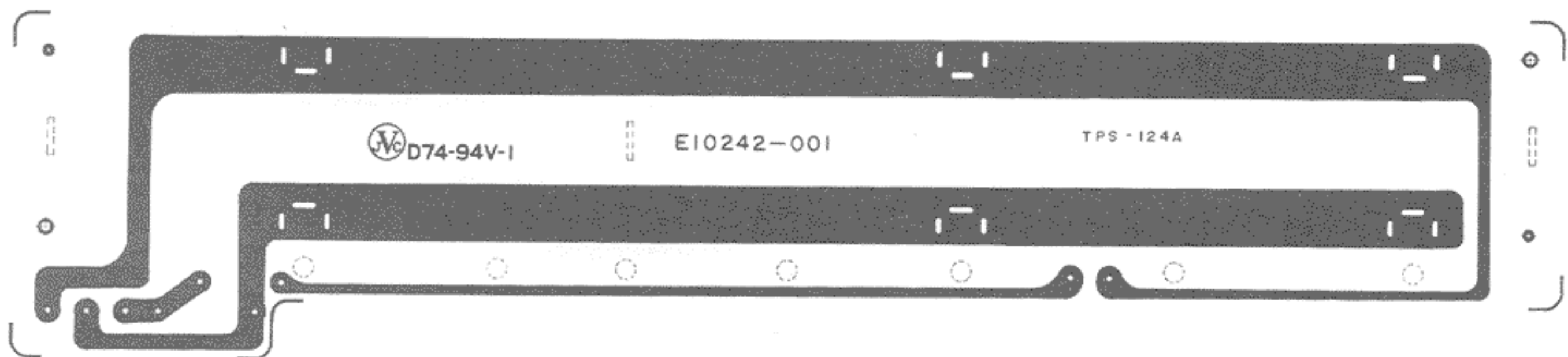

Fig. 28

Others

Item No.	Part Number	Rating	Description
R921	QRG017J-181 E45524-001	1 W	Uninflammable O.M. Contact clip

7-(5) TAP-256C Audio Amp.P.C.Board Ass'y

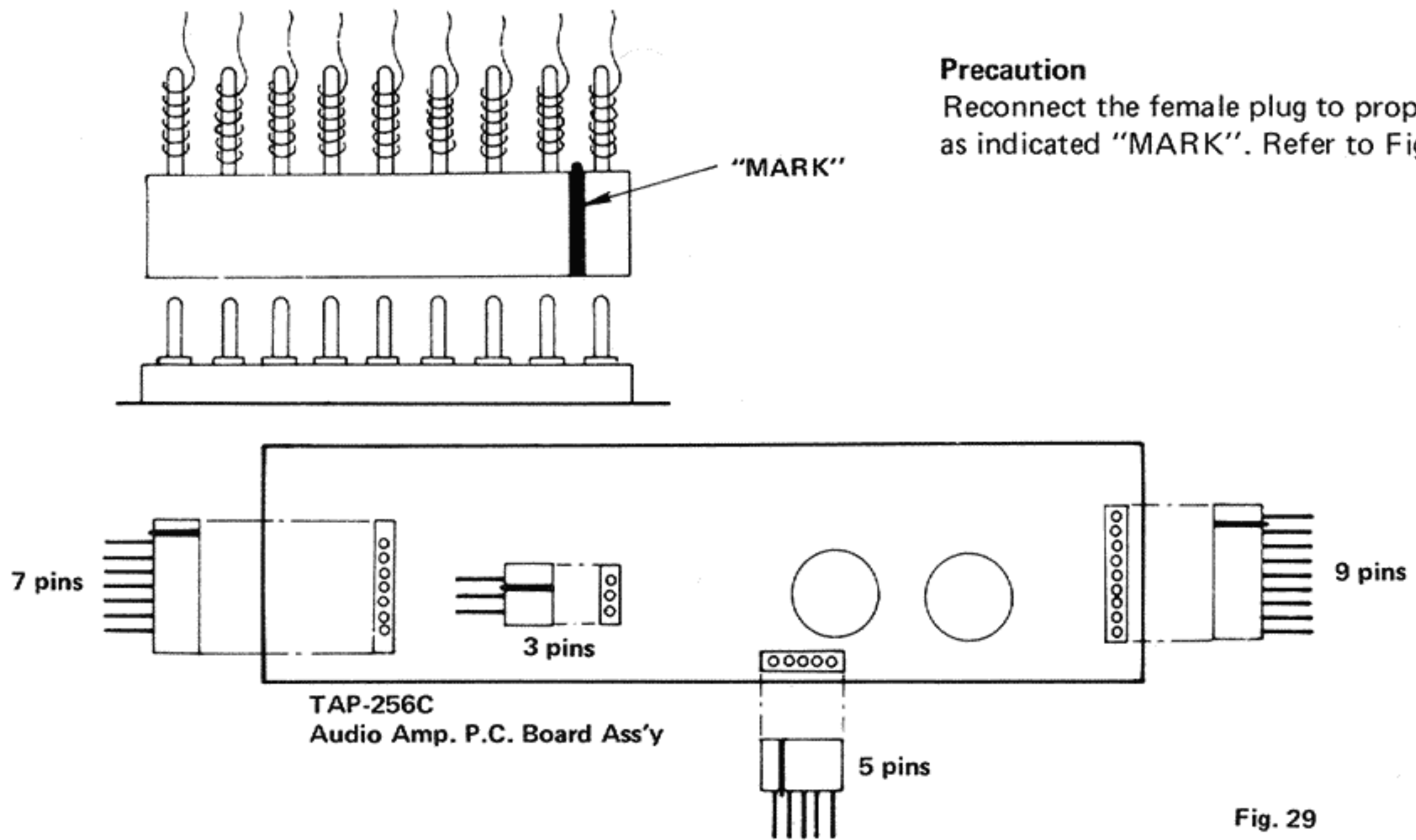

Fig. 29

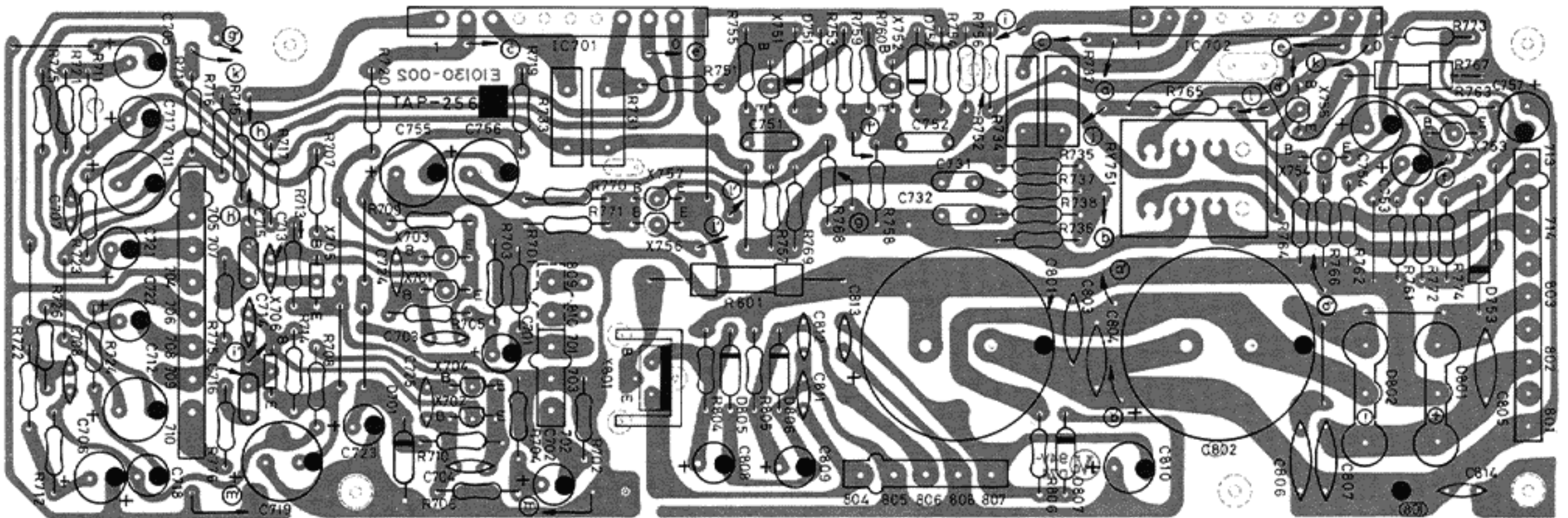

Fig. 30

Transistors

Item No.	Part Number	Rating		Description	Maker
		Pc	fT		
X701	2SA872AV(E)	300 mW	200 MHz	Silicon Transistor	Hitachi
X702	2SA872AV(E)	"	"		
X703	2SA872AV(E)	"	"		
X704	2SA872AV(E)	"	"		
X705	2SC1628(O)/2SC1904(V)	1 W	120 MHz	"	Toshiba/Fujitsu
X706	2SC1628(O)/2SC1904(V)	"	"		
X751	2SC1775AV(F)	300 mW	200 MHz	"	Hitachi
X752	2SC1775AV(F)	"	"		
X753	2SA872AV(E)	"	"		
X754	2SC1775AV(F)	"	"	"	Sanyo
X755	2SD438(E)	750 mW	100 MHz		
X756	2SA872AV(E)	300 mW	200 MHz	"	Hitachi
X757	2SC1775AV(F)	"	"		
X801	2SD330V(E)	20 W	8 MHz	"	Sanyo

Integrated Circuits

Item No.	Part Number	Rating	Description	Maker
IC701	STK-0040		Power Integrated Circuit	Sanyo
IC702	STK-0040		"	"

Diodes

Item No.	Part Number	Rating	Description
D701	WZ130		Zener Diode
D751	1S2473		Silicon
D752	1S2473		"
D753	SIB01-02		"
D801	ESAC04-02C		"
D802	ESAC04-02N		"
D805	WZ130		Zener Diode
D806	WZ130		"
D807	WZ130		"

Capacitors

Item No.	Part Number	Rating		Description
C701	QEB41EM-475	4.7 μ F	25 V	L.L.C. Electrolytic
C702	QEB41EM-475	"	"	"
C703	QCS11HJ-471	470 pF	50 V	Ceramic
C704	QCS11HJ-471	"	"	"
C705	QEW41CA-476	47 μ F	16 V	Electrolytic
C706	QEW41CA-476	"	"	"
C707	QCS11HJ-180	18 pF	50 V	Ceramic
C708	QCS11HJ-180	"	"	"
C711	QEW41HA-476	47 μ F	"	Electrolytic
C712	QEW41HA-476	"	"	"
C713	QCS11HJ-5R0	5 pF	"	Ceramic
C714	QCS11HJ-5R0	"	"	"
C715	QFM41HK-333	0.033 μ F	"	Mylar
C716	QFM41HK-333	"	"	"
C717	QEW41CA-106	10 μ F	16 V	Electrolytic
C718	QEW41CA-106	"	"	"
C719	QEW41HA-107	100 μ F	50 V	"
C721	QEW41CA-106	10 μ F	16 V	"
C722	QEW41CA-106	"	"	"
C723	QEW41HA-475	4.7 μ F	50 V	"
C731	QFM41HK-473	0.047 μ F	"	Mylar
C732	QFM41HK-473	"	"	"
C751	QFM41HK-104	0.1 μ F	"	"
C752	QFM41HK-104	"	"	"
C753	QEW41EA-106	10 μ F	25 V	Electrolytic
C754	QEW41AA-476	47 μ F	10 V	"
C755	QEW41AA-227	220 μ F	"	"
C756	QEW41AA-227	"	"	"
C757	QEW41CA-106	10 μ F	16 V	"

Capacitors

Item No.	Part Number	Rating		Description
C801	QEW71GH-688	6800 μ F	42 V	Electrolytic
C802	QEW71GH-688	"	"	"
C803	QCF12HP-103	0.01 μ F	50 V	Ceramic
C804	QCF12HP-103	"	"	"
C805	QCF12HP-103	"	"	"
C806	QCF12HP-103	"	"	"
C807	QCF12HP-103	"	"	"
C808	QEW41VA-107	100 μ F	35 V	Electrolytic
C810	QEW41VA-227	"	"	"
C811	QCF11HP-103	0.01 μ F	50 V	Ceramic

Resistors

Item No.	Part Number	Rating		Description
R701	QRD141J-474	470 k Ω	1/4 W	Carbon
R702	QRD141J-474	"	"	"
R703	QRD141J-683	68 k Ω	"	"
R704	QRD141J-683	"	"	"
R705	QRD141J-222	2.2 k Ω	"	"
R706	QRD141J-222	"	"	"
R707	QRD141J-222	"	"	"
R708	QRD141J-222	"	"	"
R709	QRD141J-153	15 k Ω	"	"
R710	QRD141J-153	"	"	"
R711	QRD141J-102	1 k Ω	"	"
R712	QRD141J-102	"	"	"
R713	QRG129J-182	1.8 k Ω	1/2 W	Unflammable O.M.
R714	QRG129J-182	"	"	"
R715	QRG129J-272	2.7 k Ω	"	"
R716	QRG129J-272	"	"	"
R717	QRG129J-392	3.9 k Ω	"	O.M.
R718	QRG129J-392	"	"	"
R719	QRD126J-472	4.7 k Ω	"	Unflammable Carbon
R720	QRD126J-390	39 Ω	"	"
R721	QRD141J-473	47 k Ω	1/4 W	Carbon
R722	QRD141J-473	"	"	"
R723	QRD141J-562	5.6 k Ω	"	"
R724	QRD141J-562	"	"	"
R725	QRD141J-472	4.7 k Ω	"	"
R726	QRD141J-472	"	"	"
R731	QRM054K-R47	0.47 Ω	5 W	Metal Plate
R732	QRM054K-R47	"	"	"
R733	QRM054K-R47	"	"	"
R734	QRM054K-R47	"	"	"
R735	QRD126J-102	1 k Ω	1/2 W	Unflammable Carbon
R736	QRD126J-102	"	"	"
R737	QRD126J-100	10 Ω	"	"

Resistors

Item No.	Part Number	Rating		Description
R738	QRD126J-100	10 Ω	1/2 W	Uninflammable Carbon
R751	QRD141J-222	2.2 k Ω	1/4 W	Carbon
R752	QRD141J-222	"	"	"
R753	QRD141J-562	5.6 k Ω	"	"
R754	QRD141J-562	"	"	"
R755	QRD141J-101	100 Ω	"	"
R756	QRD141J-101	"	"	"
R757	QRD141J-471	470 Ω	"	"
R758	QRD141J-471	"	"	"
R759	QRD141J-123	12 k Ω	"	"
R760	QRD141J-123	"	"	"
R761	QRD141J-104	100 k Ω	"	"
R762	QRD141J-471	470 Ω	"	"
R763	QRD141J-103	10 k Ω	"	"
R764	QRD141J-224	220 k Ω	"	"
R765	QRD141J-103	10 k Ω	"	"
R766	QRD141J-823	82 k Ω	"	"
R767	QRG017J-221	220 Ω	1 W	Uninflammable O.M.
R768	QRD141J-223	22 k Ω	1/4 W	Carbon
R769	QRD141J-223	"	"	"
R770	QRD141J-562	5.6 k Ω	"	"
R771	QRD141J-822	8.2 k Ω	"	"
R772	QRD141J-822	"	"	"
R773	QRD126J-152	1.5 k Ω	1/2 W	Uninflammable Carbon
R774	QRD126J-222	2.2 k Ω	"	"
R801	QRG037J-101	100 Ω	3 W	O.M.F.
R804	QRG129J-472	4.7 k Ω	1/2 W	Uninflammable O.M.F.
R806	QRG129J-122	1.2 k Ω	"	"

Others

Item No.	Part Number	Rating		Description
RY751	ESK1D24-216			Relay
	E03628-3			3p Plug
	E03628-5			5 Pin Plug
	E03628-7			7 Pin Plug
	E03628-9			9p Plug
	E22011-001			Heat Sink for Power I.C.s
	E34453-001			Heat Sink Holder
	E34453-002			"
	E60171-001			Heat Sink for 2SD330V(E)

7-(6) TAC-491 Volume and Tone Control P.C. Board Ass'y

Replacement of TAC-491

Before replacing TAC-491, remove TAP-256C Audio Amp. P.C. Board according to the Removal Procedure instructed on page 8.

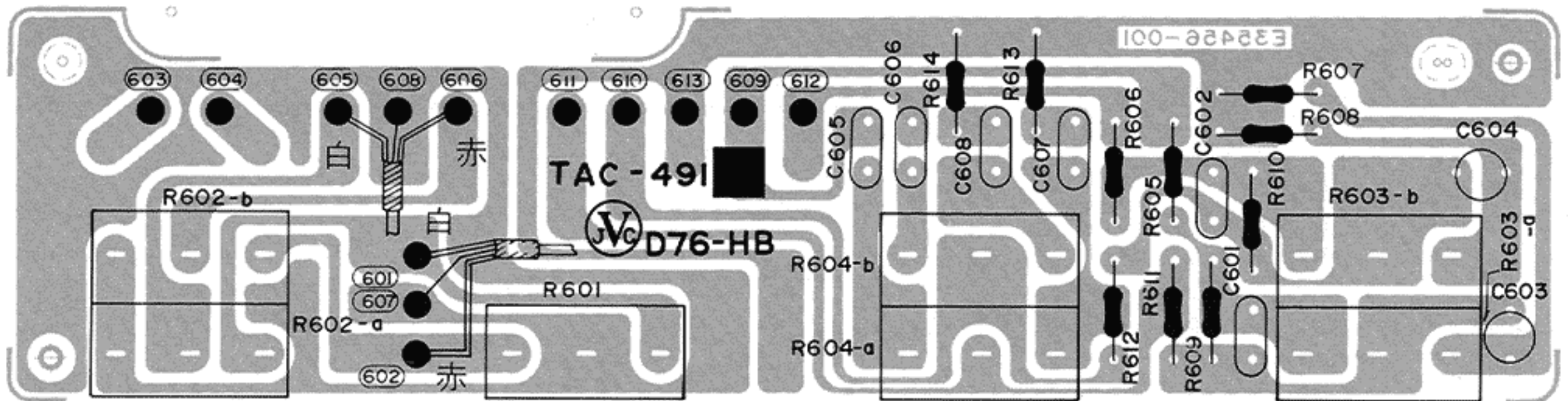

Fig. 31

Capacitors

Item No.	Part Number	Rating		Description
C601	QFM31HK-273	0.027 μ F	50 V	Mylar
C602	QFM31HK-273	"	"	"
C603	QEZ0046-224	0.22 μ F	"	Non Polar Electrolytic
C604	QEZ0046-224	"	"	"
C605	QFM31HK-332	3300 pF	"	Mylar
C606	QFM31HK-332	"	"	"
C607	QFM31HK-333	0.033 μ F	"	"
C608	QFM31HK-333	"	"	"

Resistors

Item No.	Part Number	Rating		Description
R601	QVB8A2W-6F5V			Variable Resistor (Balance)
R602	QVZ1219-002			" " (Volume)
R603	QVC3A2C-215V			" " (")
R604	QVC3A2C-215V			" " (")
R605	QRD141J-123S	12 k Ω	1/4 W	Carbon
R606	QRD141J-123S	"	"	"
R607	QRD141J-152S	1.5 k Ω	"	"
R608	QRD141J-152S	"	"	"
R609	QRD141J-104S	100 k Ω	"	"
R610	QRD141J-104S	"	"	"
R611	QRD141J-182S	1.8 k Ω	"	"
R612	QRD141J-182S	"	"	"
R613	QRD141J-561S	560 Ω	"	"
R614	QRD141J-561S	"	"	"

Others

Item No.	Part Number	Rating	Description
	E03565-3B0		3 pins Socket
	E03565-5B0		5 pins Socket
	E03565-7B0		7 pins Socket
	E61102-001		Lug

8. Packing Materials and Part Numbers

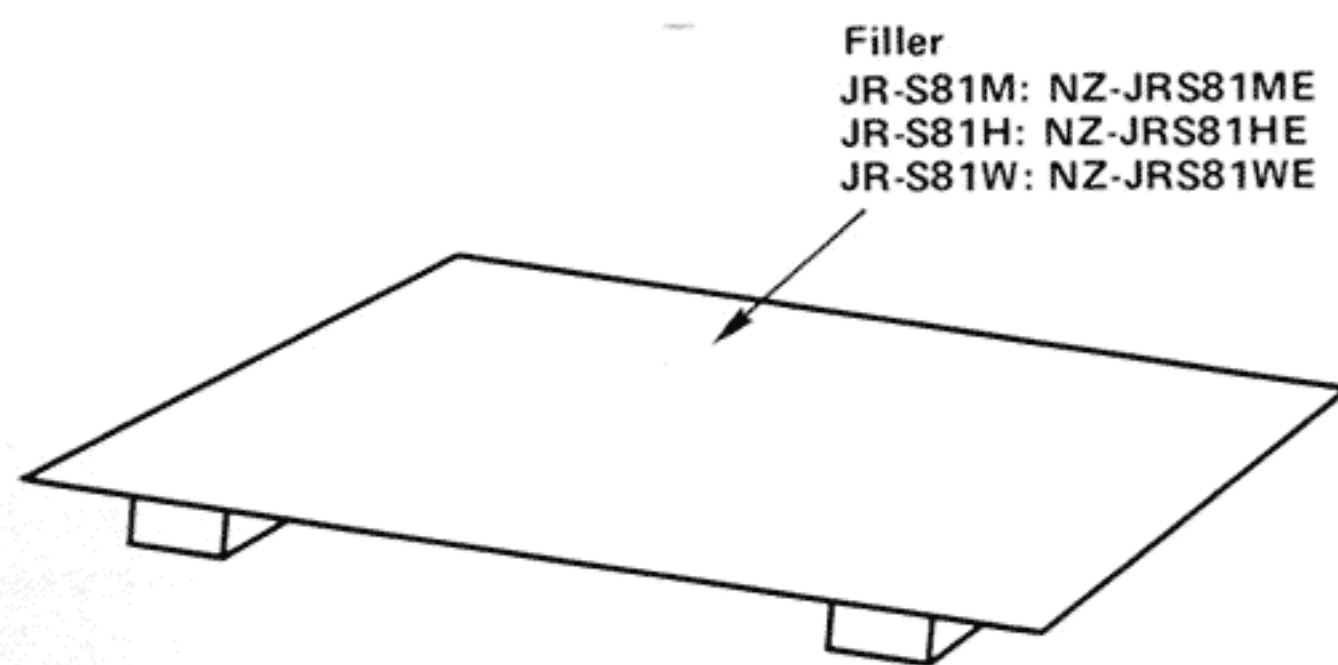

Fig. 32

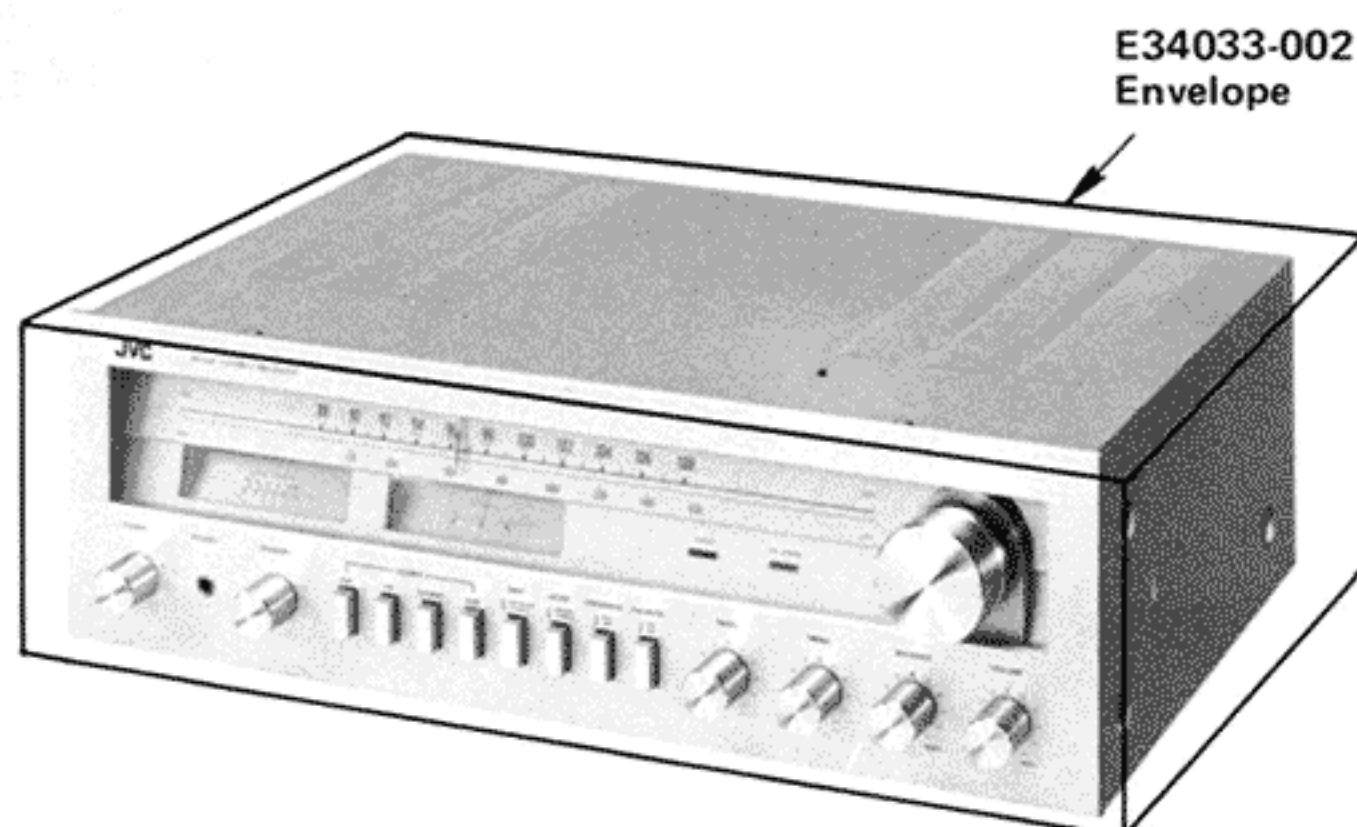

Fig. 33

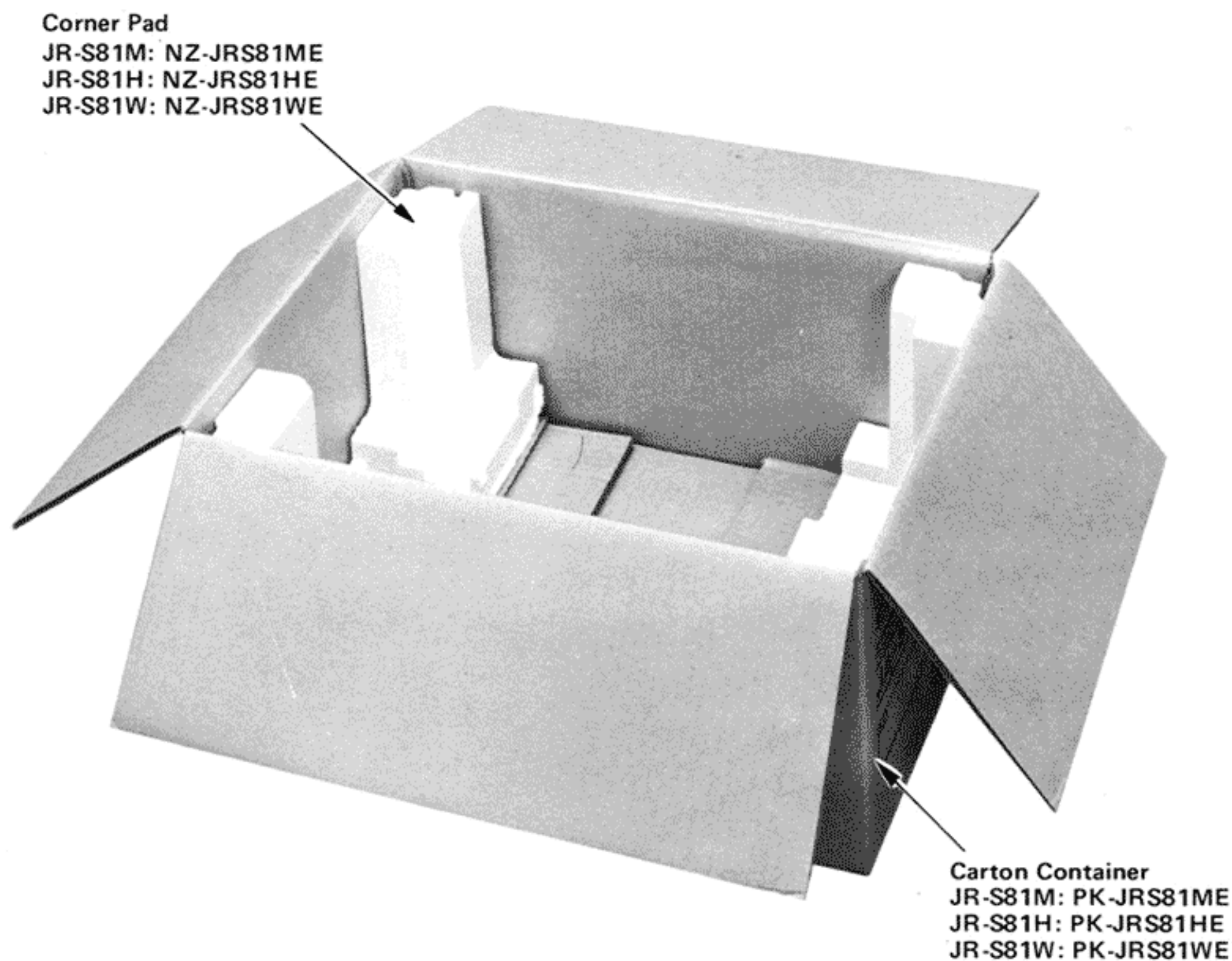
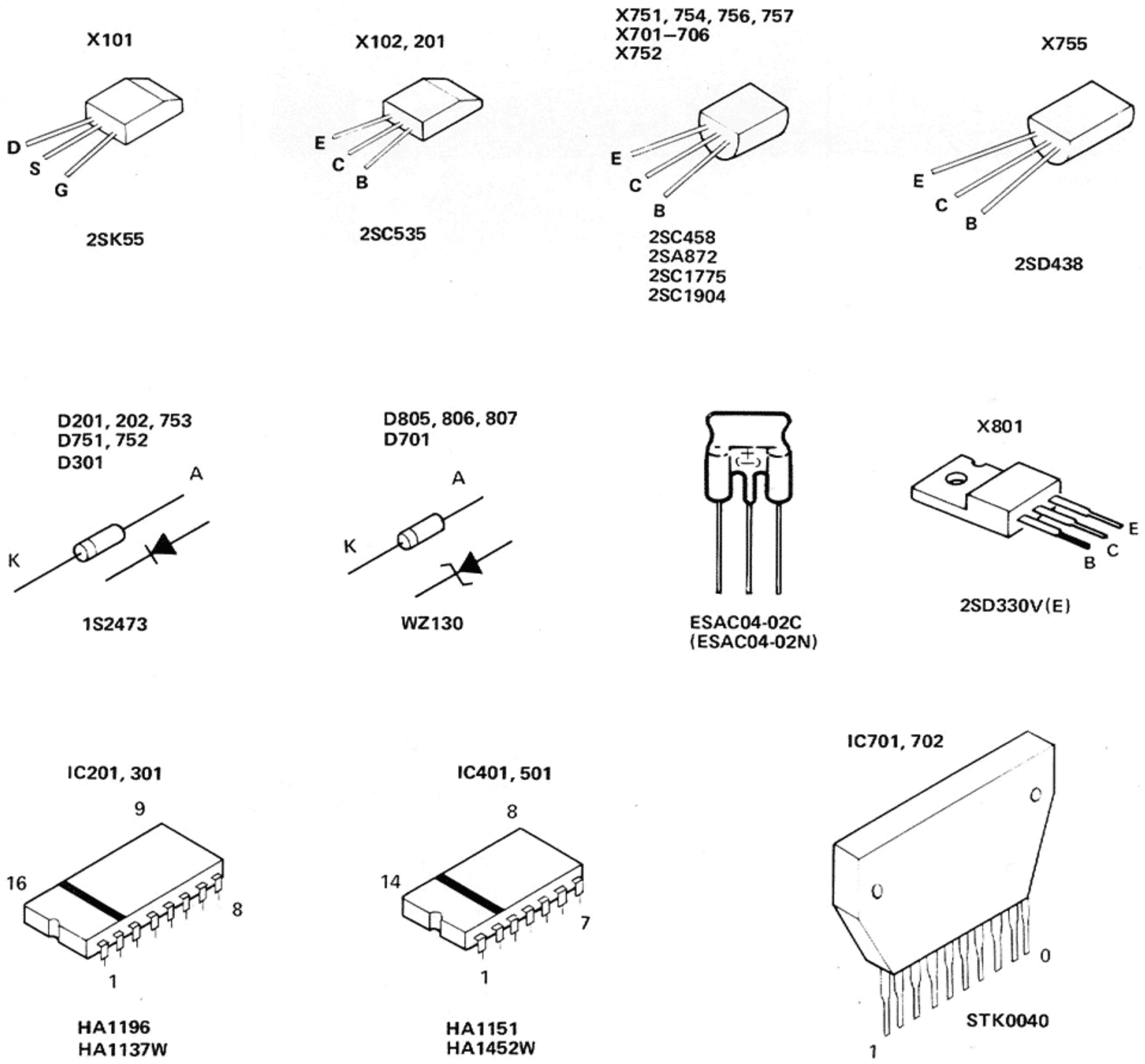

Fig. 34

9. Accessories List

Item No.	Part Number	Description	Q'ty
1	See page 30.	Instruction Book (Different in different areas)	1
2	See page 30.	Warranty Card (Different in different areas)	1
3	E64207-002	Envelope for Instruction Book & Others	1
4	BT20024	"Do It Better" (for U.S.A. only)	1
5	BT20023	Service Procedures (for U.S.A. only)	1
6	E03614-002	FM Antenna (for Australia, U.K. & Europe only)	1
7	QMF60R1-4R0	4.0 AT Fuse (for 120 V used in Military Market only)	1
8	QMF60R1-2R3	2.3 AT Fuse (for 220 V used in Military Market only)	1
9	E64216-002	Caution Tag (with Power Cord) (for Military Market only)	1
10	E64208-001	Envelope for Fuses (Military Market only)	1
11	E48251-001	Plug Cover for Power Cord (for Australia only)	1

10. Transistor, I.C. and Diode Lead Identification



[A] FOR AUSTRALIA PRIMARY AC 240V, 50Hz ~ (FM DE-EMPHASIS 75 μSEC)
 [BS] FOR U. K.

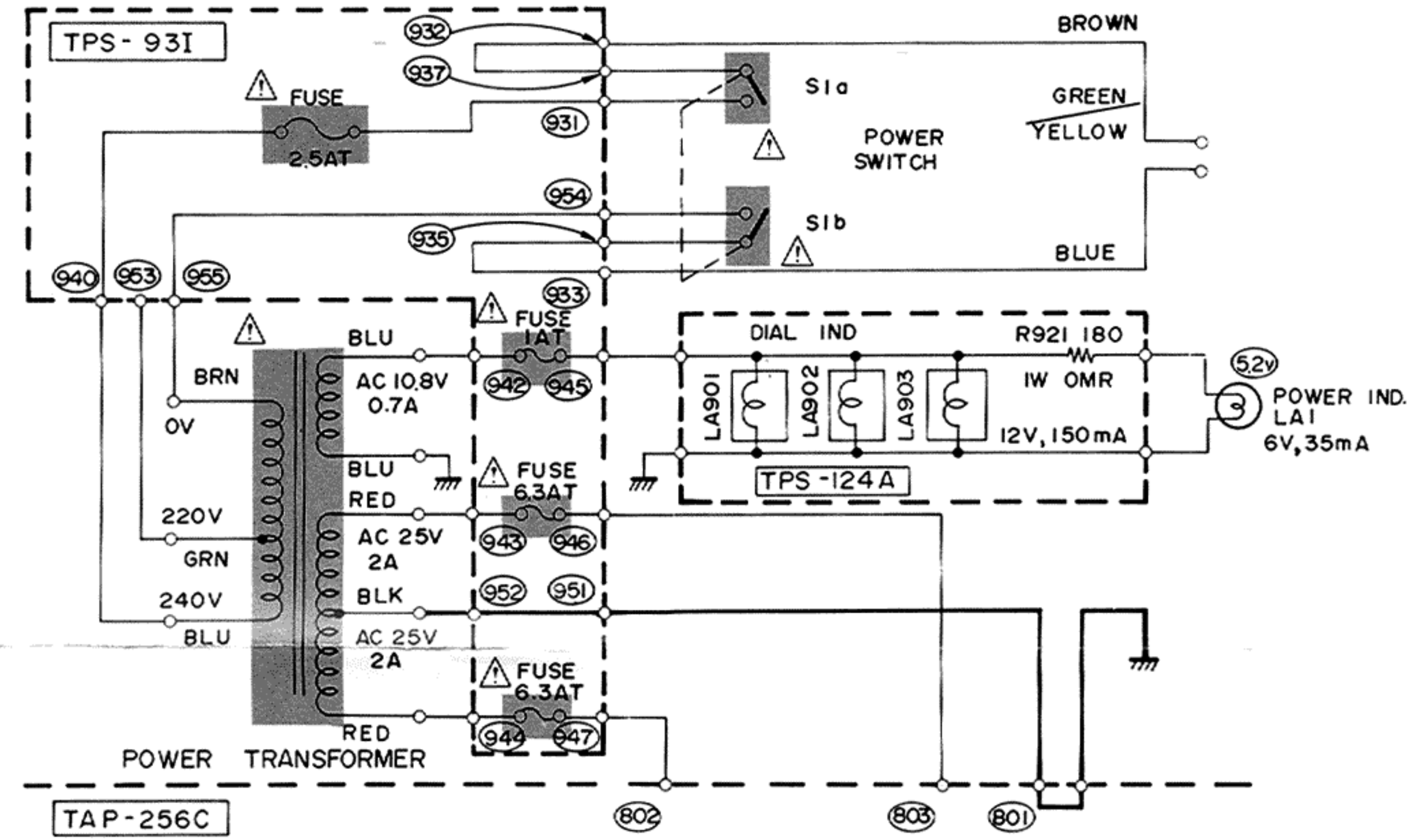

[C] FOR CANADA PRIMARY AC 120V 60Hz (FM DE-EMPHASIS 75 μSEC)

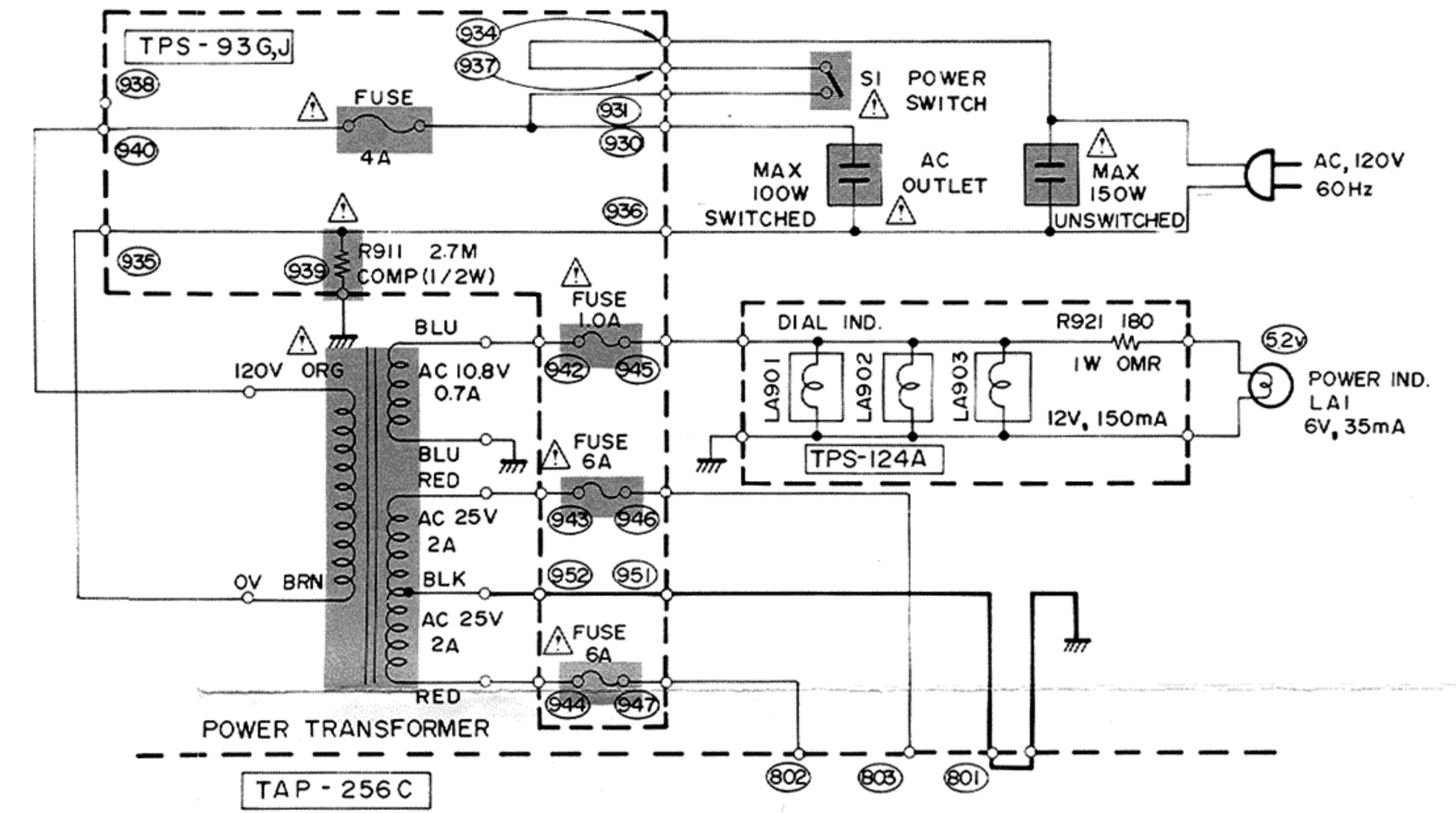

NOTE : THERE ARE NO FUSES (1A & 6A) FOR AMERICA [J]



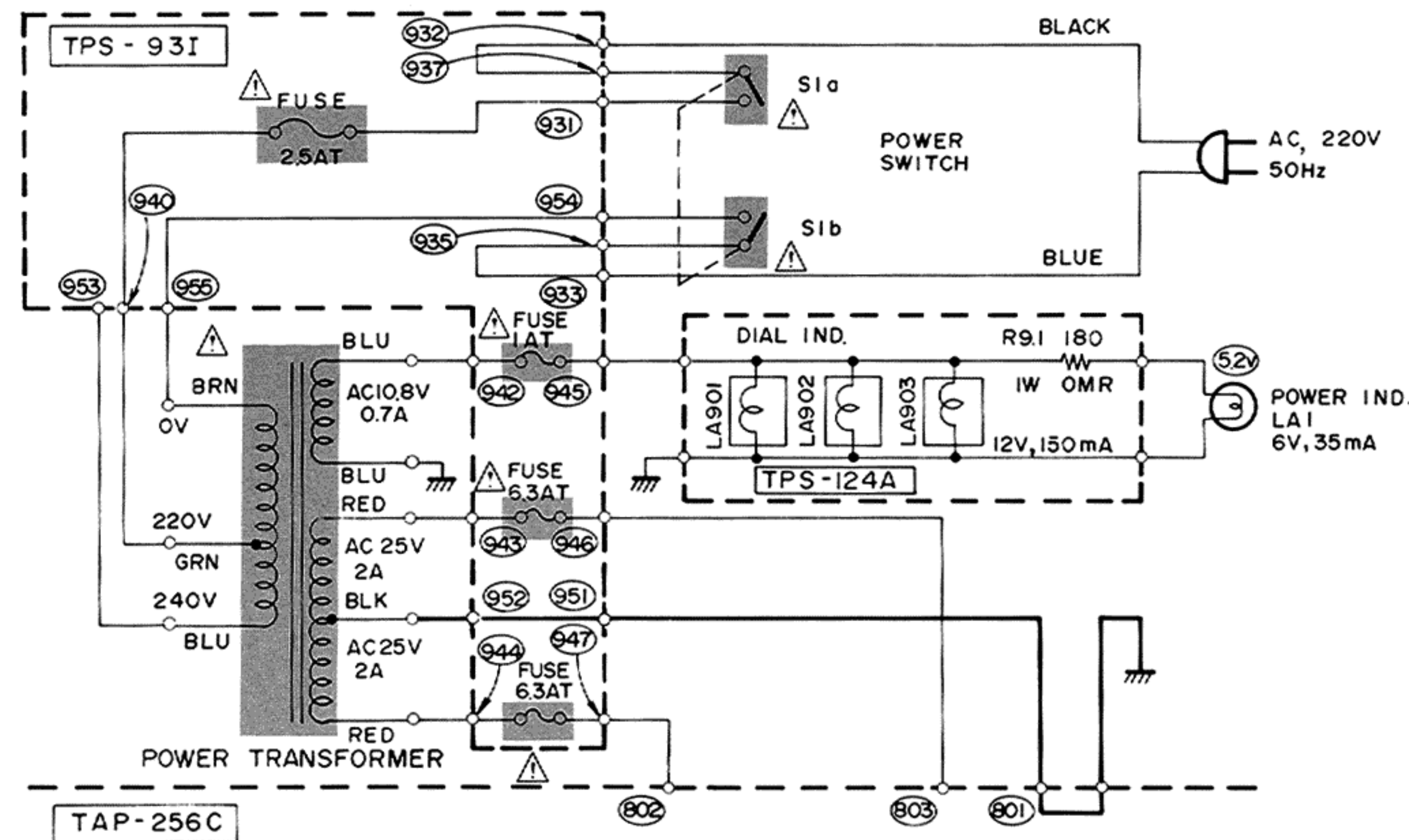



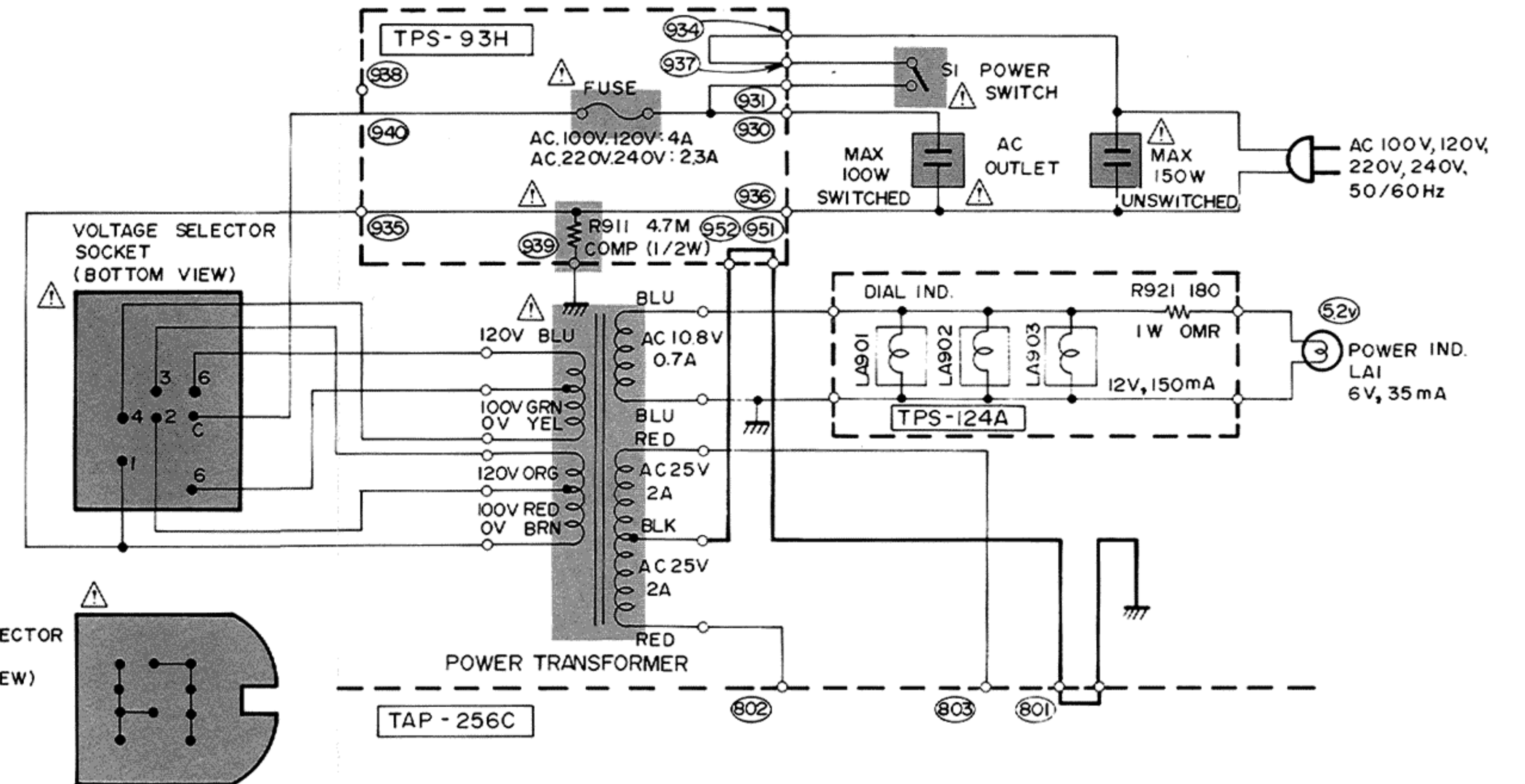





[E] FOR EUROPE PRIMARY AC 220V, 50Hz ~ (FM DE-EMPHASIS 50 μSEC)



[P] FOR PACEX (FM DE-EMPHASIS 75 μ SEC) PRIMARY
 [U] FOR OTHER COUNTRIES (FM DE-EMPHASIS 75 μ SEC) AC 100V, 120V, 220V, 240V,
 [F] FOR OTHER COUNTRIES (FM DE-EMPHASIS 50 μ SEC) 50/60Hz



12. Parts List with Specified Numbers for Designated Areas

Page	Item No.	Description	For U.S.A.	For Canada	For Australia	For U.K.	For European countries	For PACEX and other countries
4		Power Transformer 	E03077-20	E03077-20	E03077-20C	E03077-20DBS	E03077-20C	E03077-20B
5	12	Power Switch 	QSR0088-001	QSR0088-001	QSR0088-002	QSR0088-002BS	QSR0088-002	QSR0088-002
6	7	Power Cord 	QMP1200-244	QMP1200-244	QMP2610-200	QMP9017-008BS	QMP3910-244	QMP1200-244
6	6	Power Cord Stopper 	QHS3876-162	QHS3876-162	QHS3876-162	QHS3876-162BS	QHS3876-162	QHS3876-162
		AC Outlet 	QMC0437-001	QMC0437-001	—	—	—	QMC0437-001
		Covering Plate 	—	—	E61079-003	E61079-003	E61079-003	—
19	7-(2)	AC Fuse P.C. Board Ass'y 	TPS-93J	TPS-93G	TPS-93I	TPS-93IBS	TPS-93I	TPS-93H
19	7-(2)	Contact Clip 	E45524-001	E45524-001	E48965-002	E48965-002BS	E48965-002	E45524-001
19	7-(2)	Composition Resistor 	QRC121K-275E (2.7 MΩ/1/2 W)	QRC121K-275E (2.7 MΩ/1/2 W)	—	—	—	QRC121K-475E (4.7 MΩ/1/2 W)
27	1	Instruction Book	E30580-657A	E30580-659A	E30580-659A	E30580-657ABS	E30580-659A	E30580-659A
27	2	Warranty Card	BT20020C	BT20025	BT20029	BT20013BBS	—	BT20014B
19	7-(2)	Fuse (Primary) 	QMF61U1-4R0 (4 A)	QMF60R1-4R0 (4 A)	QMF51A2-2R5 (2.5 AT)	QMF51A2-2R5BS (2.5 AT)	QMF51A2-2R5 (2.5 AT)	QMF60R1-2R3 (2.3 A) or QMF60R1-4R0 (4 A)
19	7-(2)	Fuse (Secondary) 6 A or 6.3A 	—	QMF60R1-6R0 (6 A)	QMF51A2-6R3 (6.3 AT)	QMF51A2-6R3BS (6.3 AT)	QMF51A2-6R3 (6.3 AT)	—
		1 A 	—	QMF60R1-1R0	QMF51A2-1R0	QMF51A2-R0BS	QMF51A2-1R0	—

NOTE:  SAFETY PARTS

JVC

VICTOR COMPANY OF JAPAN, LIMITED, TOKYO, JAPAN



Printed in Japan
7012-V